

# db

THE SOUND ENGINEERING MAGAZINE

MAY 1969 75c

Tape Delay Systems

U.S. Senate Sound System

Improved Quality from Magnetic Tape

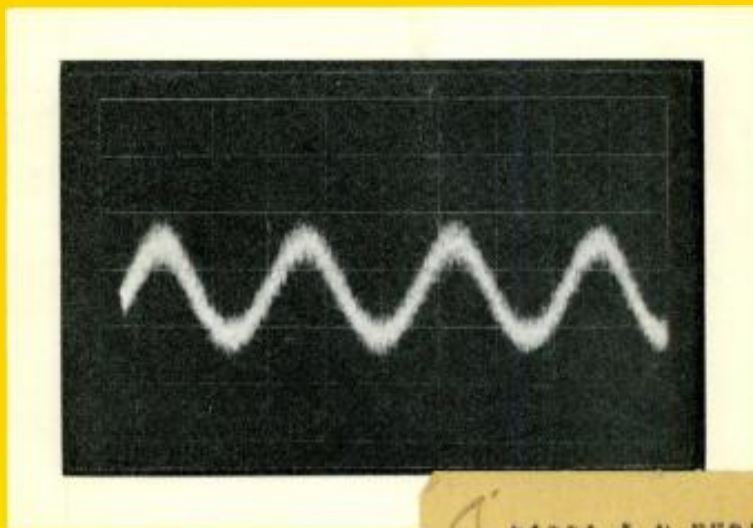

INTERNATIONAL  
-ELECTROACOUSTICS INC  
323 6TH AVE  
NEW YORK N Y 10014

# Only Sony's got 'em



The world's only  
22-inch condenser  
tele-mike.



The FET version  
of the famous  
C-37.



The world's first  
positionable capsule  
for multi-applications.

Innovation through imagination. This is the guideline Sony engineers follow in creating superior microphones for the professional. For example, the C-55's cardioid condenser capsule can be positioned in whatever direction is desired. With the C-77, Sony has shrunk the ordinary, cumbersome tele-microphone to an incredible 22 inches, made it a condenser and achieved fantastic frequency response plus superb hyperdirectionality at all frequencies, from 40 to 12 KHz. And now Sony offers a completely transistorized ver-

sion of the brilliant C-37 A in the C-37 FET. Whichever Sony microphone you choose, you're sure of technical excellence and performance reliability that has successfully met the most critical standards in the world. For complete details and specifications, please write Mr. Charles Bates, Sony/Superscope, 8150 Vineland Ave., Sun Valley, Calif. 91352.

**SONY** **SUPERSCOPE**

You never heard it so good.

Circle 5 on Reader Service Card

[www.americanradiohistory.com](http://www.americanradiohistory.com)

# Coming Next Month

● Next month we will have the promised picture gallery of equipment shown at the NAB Convention recently held in Washington, D. C. There was a lot to be seen.

The increased tendency to build halls for multiple purpose presents unusual challenges to sound reinforcement installations. A solution applied to one such hall in Bergen, Norway is the topic for **MULTI-PURPOSE HALLS PRESENT PROBLEMS**.

**THE ULTIMATE NOISE** is the provocative title Mel Sprinkle has given to his article. It explores the mathematics and practicalities of pushing away the thermal noise that is still left in our equipment.

And there will be our regular columnists, George Alexandrovich, Norman H. Crowhurst, Arnold Schwartz, and Martin Dickstein. Coming in **db**, the Sound Engineering Magazine.

# About the Cover

● Tape wide-band noise rides in on hum in this all-to-characteristic oscilloscope photograph of a medium-cost tape recorder seen in some professional quarters. See Max R. Cannon's article **IMPROVED TAPE QUALITY** beginning on page 24.

# db

THE SOUND ENGINEERING MAGAZINE

MAY 1969 • Volume 3, Number 5

## Table of Contents

### FEATURE ARTICLES

- Tape Delay Systems  
*John M. Woram* 20
- U. S. Senate Sound System 22
- Improved Tape Quality  
*Max R. Cannon* 24

### MONTHLY DEPARTMENTS

- Letters 2
- The Audio Engineer's Handbook  
*George Alexandrovich* 4
- The Feedback Loop  
*Arnold Schwartz* 10
- Editorial 18
- Theory and Practice  
*Norman H. Crowhurst* 28
- Sound with Images  
*Martin Dickstein* 33
- New Products and Services 36
- The db Bookcase 38
- Classified 39
- People, Places, Happenings 40

### EDITORIAL BOARD OF REVIEW

George Alexandrovich  
Sherman Fairchild  
Norman Anderson  
Prof. Latif Jiji  
Daniel R. von Recklinghausen  
William L. Robinson  
Paul Weathers  
John H. McConnell

**db**, the Sound Engineering Magazine is published monthly by Sagamore Publishing Company, Inc. Entire contents copyright © 1969 by Sagamore Publishing Co., Inc., 980 Old Country Road, Plainview, L.I., N.Y. 11803. Telephone (516) 433-6530. **db** is distributed to qualified individuals and firms in professional audio—recording, broadcast, audio-visual, sound reinforcement, consultants, video recordings, film sound, etc. Application must be made on an official subscription form or on a company letterhead. Subscriptions are \$6.00 per year (\$7.00 per year outside U. S. Possessions, Canada, and Mexico) in U. S. funds. Single copies are 75c each. Controlled Circulation postage paid at Easton, Pa. 18042. Editorial, Publishing, and Sales Offices: 980 Old Country Road, Plainview, New York 11803. Postmaster: Form 3579 should be sent to above address.

## 4 or 8 Channel BUDGETABILITY

**Need 4 or 8 channel mixer-equalizer capability?  
Are you shocked at console prices of \$5000 up?  
Would you like to spend less than 1/2 the amount?  
... then check with Gately before you buy!**

### GATELY ELECTRONICS



57 WEST HILLCREST AVENUE  
HAVERTOWN, PENNA. 19083  
AREA CODE 215 • HI 6-1415  
...have you checked Gately lately?

# Letters

The Editor:

I would like to make some comments on the article that appeared in the January 1969 issue of db magazine. This was the article on the Electronic Telephone Patch by Ronald Pesha.

This circuit and the article almost are the same as the unit that is now being installed at radio stations throughout the Bell System area. This unit is identified by the Bell System as a recorder connector and the model number is KS-19645-1.2. This recorder connector has an a.g.c. circuit and its output is 600 ohms to match most of the audio consoles in use today. This unit may be placed on an instrument or on a line and it will increase the input of the phone conversation to the level of 0 dBm; if the local phone has a level of more than 0 dBm it will reduce it and raise the outside level to 0 dBm. Of course, on conversations that are quite weak the background level will also be raised along with the conversation.

At Station WARE the unit is installed on the instrument instead of on the line so that all the lines on that instrument may use the same recorder connector and therefore feed into the same console. This allows for other recorder connectors to be used on other phones and as we have only three instruments connected we can use all four of our lines into consoles. A station with many lines into an instrument could, by placing the recorder connector on the instrument, feed any one of these lines into a console.

One other feature of this recorder-connector is the muting of the beep on the line to the console but it feeds this beep down the line to the other person, as required by the telephone tariffs.

Burton Landry  
Chief Engineer  
Station WARE  
Ware, Massachusetts

Robert Bach  
PUBLISHER

Larry Zide  
EDITOR

Bob Laurie  
ART DIRECTOR

Marilyn Gold  
COPY EDITOR

Charles N. Wilson  
ASSISTANT EDITOR

Richard L. Lerner  
ASSISTANT EDITOR

A. F. Gordon  
CIRCULATION MANAGER

Eloise Beach  
ASST. CIRCULATION MGR.

### SALES OFFICES

New York  
980 Old Country Road  
Plainview, N.Y. 11803  
516-433-6530

Denver  
Roy McDonald Associates, Inc.  
846 Lincoln Street  
Denver, Colorado 80203  
303-825-3325

Houston  
Roy McDonald Associates, Inc.  
3130 Southwest Freeway  
Houston, Texas 77006  
713-529-6711

Tulsa  
Roy McDonald Associates, Inc.  
2570 S. Harvard Ave.  
Tulsa, Oklahoma 74114  
918-742-9961

Dallas  
Roy McDonald Associates, Inc.  
Semmons Tower West  
Suite 411  
Dallas, Texas 75207  
214-637-2444

San Francisco  
Roy McDonald Associates, Inc.  
625 Market Street  
San Francisco, California 94105  
415-397-5377

Los Angeles  
Roy McDonald Associates, Inc.  
1313 West 8th Street  
Los Angeles, California 90018  
213-483-1304

Portland  
Roy McDonald Associates, Inc.  
2305 S. W. 58th Avenue  
Portland, Oregon 97221  
503-292-8521

Rx

Dr. Audio Pro's prescription for healthy recordings

*Crown  
Integrated  
Mastering  
System*

**Rx for  
On-location  
Mastering**

Modern tape-recording science announces a breakthrough in mastering technique—the Crown Integrated Mastering System with CX822 or CX844 tape recorder. It is a complete mastering system including computer-logic controlled transport, loZ mic input mixers (2/channel), headphone amps, bass and treble equalizer for each channel, built-in echo option, trac-sync, and rugged carrying case, all in one compact unit. The Crown Integrated Mastering System is a "sure cure" for on-location mastering sessions suffering from these ills:

**SYMPTOMS**

1. Feverish activity, indigestion and hypertension
2. Recordings muffed; clients upset or lost
3. Recording crew discouraged with technical problems

**DIAGNOSIS**

1. Equipment in many separate units, meaning a truck for transportation and cramped, cluttered recording area
2. Complicated setup, needing two or more strongmen, with never enough time to adequately check out each component
3. Innumerable cables which (if you remember them all) work perfectly until two minutes before recording time

**CURE**

1. One Crown CX822 or CX844 tape deck, each a single unit complete for mastering, easily transported and very compact
2. One-man setup with plenty of time; simply plug in microphones and headphones
3. Relax. With no space, time or cable problems, you can concentrate on creative recording, with superlative Crown quality that will delight your client.

For more information, phone 219 + 523-4919, or write Crown, Dept. DB-62, Box 1000, Elkhart, Indiana, 46514.

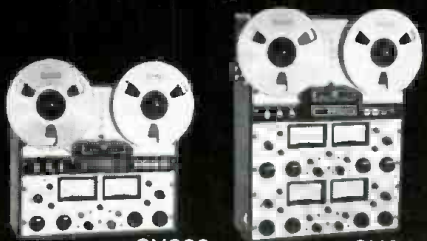

CX822

CX844

Two-channel deck \$2329 complete  
Four-channel deck \$3720 complete

Each an Integrated Mastering System!  
D40 2-channel 60w amplifier — \$199



TELETRONIX

LA-2A

## LEVELING HEAVYWEIGHT

(AMPLIFIER)

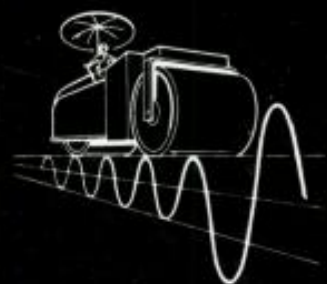

- Electro-luminescent optical gain control (Patent number 3,258,707)
- Smoother operation
- Does not color the sound
- Gain reduction does not increase harmonic generation
- Eliminates all traces of thumping

Write today for complete specifications.  
Rep and Dealer inquiries invited.

TELETRONIX

PRODUCTS OF **UREI**

11922 VALERIO STREET  
NO. HOLLYWOOD, CALIF. 91605  
TEL. (213) 764-1500

**UREI** UNITED RECORDING ELECTRONICS INDUSTRIES  
Circle 10 on Reader Service Card

# The Audio Engineer's Handbook

GEORGE ALEXANDROVICH

● Over the last several months I have received letters from readers of *db Magazine*, asking me to amplify and clarify some points in previous columns. This month it is my intention to answer a few of these questions. Since most of the questions relate to disc recording, I will start with disc-cutting problems.

Recently I happened to read several newly-presented technical papers on disc recording, involving questions on groove geometry, decreasing distortion by recording the disc backwards, and others. This clearly indicates to me that disc popularity is by no means on the decline, but has firmly entrenched itself as one of the fundamental means of preserving recorded material. The desire of the industry to achieve the ultimate in disc recording is making itself felt by the theoretical work of many well-known scientists. Their efforts have found expression through the quality of sound reproduced from the disc. This can easily be compared to the sound coming from monitor speakers while playing tape or from a live take. The average person would find it impossible to determine any differences between the three. Achievement of this level of quality of sound is due to several factors. Here are the most important ones.

1. *Original recording on tape has improved technically due to better studio techniques, better equipment, mics, amplifiers, tape machines and better tape.*

2. *Mastering techniques and equipment have improved. Better driver amplifiers, better cutters and better cutting styli.*

3. *Playback transducers have been the major improvement in sound reproduction over the past several years. Along with cartridges, there have been improvements on arms, turntables, amplifiers, and speakers.*

But, what is still the weakest link in the whole process? The mastering of the disc. The art of cutting and the

knowledge of the system along with its limitations is still unknown to many young prospects in this field. Many studios complain that they try to hire young people for disc-production rooms but are forced to turn down a great majority of apparently talented young men (although women could qualify for this job also). The reason is because of their inability to cope with disc cutting. Aside from the fact that qualified personnel are hard to find, the upkeep and performance of the equipment is left to deteriorate because of the lack of time and test equipment to maintain it at peak performance. It seems that only large recording companies are capable of sustaining maintenance crews and can experiment with new approaches and techniques.

There is a question of just how successful they may be because many small independent studios quite often overshadow their larger competitors. Most of the recording rooms, once they are set up, are not disturbed. The only changes or improvements that managers will consider are to try different cutting styli, better limiters, or some equalization. But everyone is pushing for high levels. This forces the operator to drive the recording system to its highest point before severe overload occurs.

Not every studio has 100-watt driver amplifiers and not every cutting facility has stereo cutters, but each establishment wants to outdo the others. Naturally, the results are often disastrous. Pumping enormous levels into a cutting system with limited capabilities produces distortion, unpleasant sound and, ironically, the record doesn't sound loud at all. Most of the mechanically dampened cutters used for cutting mono records exhibit fairly flat frequency response at moderate levels. But when the cutter is overdriven, mechanical damping (due to factors such as heat, poor surface tension of

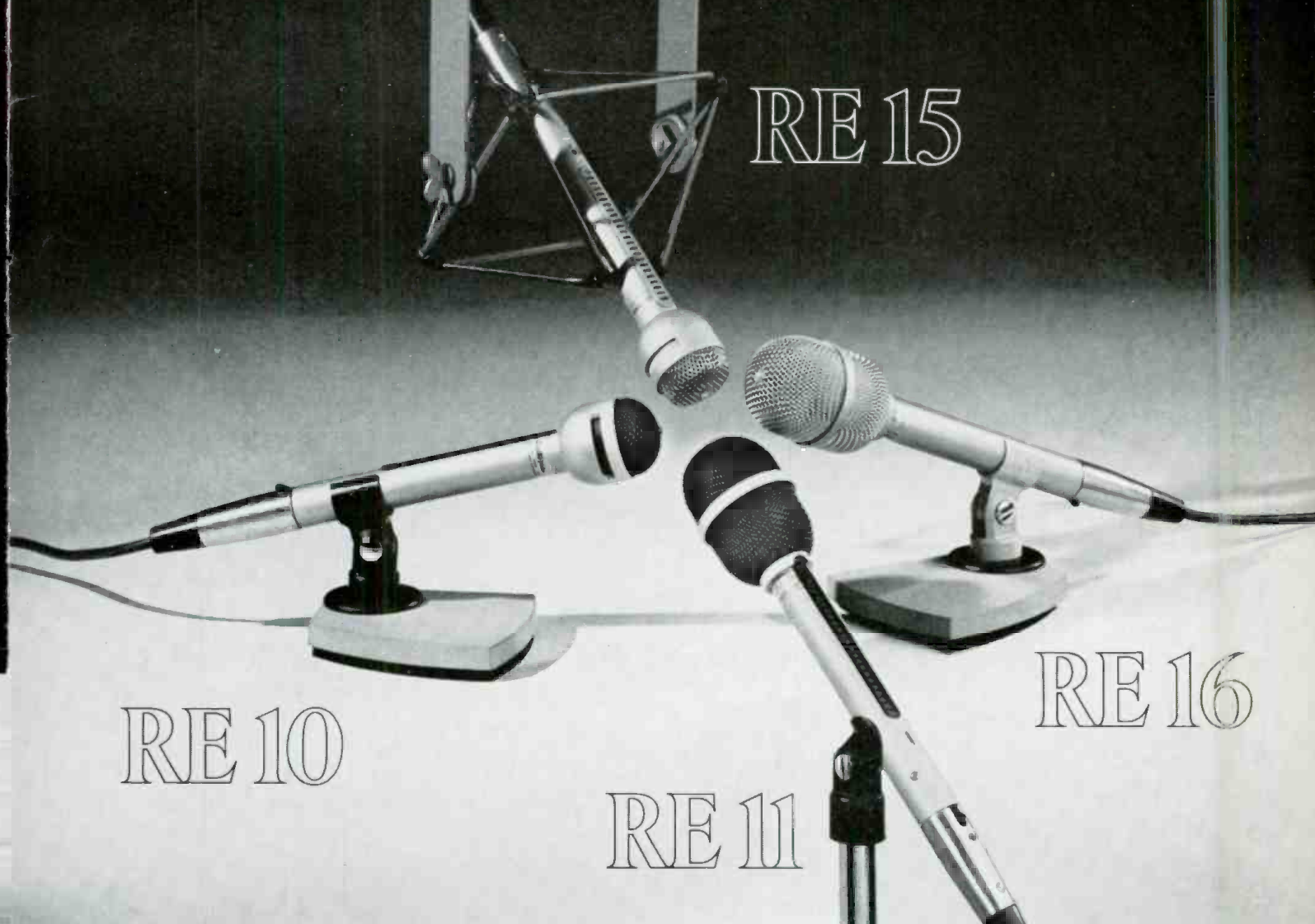

RE 15

RE 10

RE 11

RE 16

NEW Model RE10 \$90.00, shown on Model 421 desk stand \$10.50. Model RE15 \$153.00, shown with Model 307 suspension mount \$20.70. NEW Model RE11 \$96.00, shown with Model 311 snap-out stand adapter \$3.90. NEW Model RE16 \$159.00, shown on Model 421 desk stand \$10.50. All prices suggested net.

# Freedom of choice!

**E-V** Professional sound has entered a new era. It started with the Electro-Voice Model RE15. And now there are four E-V dynamic cardioid microphones that share its distinctive advantages — with some unique benefits of their own.

### Unaffected by Distance . . . Angle

Basic to all of these microphones is Exclusive Electro-Voice Continuously Variable-D\* construction. Now it offers something you've never heard before with any microphone: no matter what you do, microphone response never varies!

Whether performers almost swallow the microphone, wander far off-mike . . . or even move around to the back . . . you'll still get the same smooth response. Only the level changes.

Once you set equalization it remains constant. You have full assurance that tonal balance won't change between the dress rehearsal and the final performance, no matter what the talent does.

### Improved Cardioid Pattern

Only acoustics and noise can limit you. Yet even here these new E-V microphones gain an advantage from the super-cardioid pattern that provides better sound control than ordinary cardioids. With maximum rejection 150° off axis, it is easier to eliminate unwanted sound while maintaining normal stand or boom microphone positions. There's also an integral bass-tilt circuit to cut rumble below 100 Hz. when needed.

### Now Select from Four Models

In addition to the original RE15, we've added the RE16. The same fine microphone with an external "pop" filter to solve the problems of ultra-close miking.

The new RE10 is the economy version of the RE15. The same concept and quality, but for slightly less rigid requirements. And the RE11 is the lower cost twin to the RE16.

These four great cardioid microphones give you new freedom to head off sound problems before they start. Your E-V microphone headquarters has them waiting. Choose today.

\*U.S. Patent No. 3,115,207. Trade mark registered.

ELECTRO-VOICE, INC., Dept. 5918D  
686 Cecil Street, Buchanan, Michigan 49107

high fidelity systems and speakers • tuners, amplifiers, receivers • public address loudspeakers  
microphones • phono needles and cartridges • space and defense electronics

*Circle 13 on Reader Service Card*

[www.americanradiohistory.com](http://www.americanradiohistory.com)

**Electro-Voice**

A SUBSIDIARY OF GULTON INDUSTRIES, INC.

# STEP UP

... to the finest transcription turntable in the world!

# THORENS

If you're settling for less than the entirely new THORENS TD-125, or it's the integrated 2-speed companion, the THORENS TD-150 AB, you're making do with less than the best! THORENS TD-125; \$185.00 less base — THORENS TD-150 AB; \$110.00 with arm & base.



Endorsed by Elpa because it successfully meets the stringent standards of performance Elpa demands. Write for full THORENS details. Elpa Marketing Industries, Inc., New Hyde Park, N. Y. 11040

Circle 8 on Reader Service Card

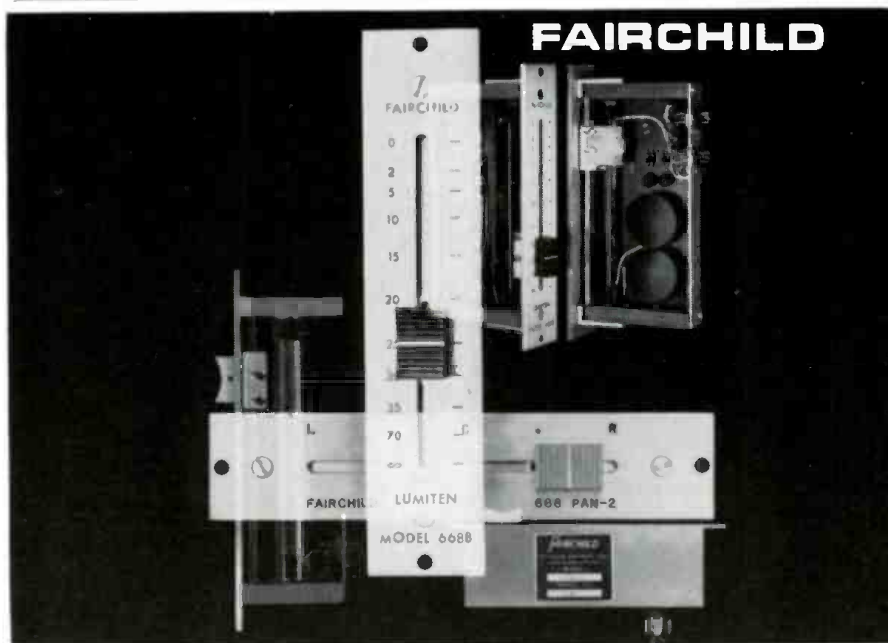

**THE NEW FAIRCHILD LUMITENS** • Fairchild introduces a complete new line of noiseless attenuators with 7 new advantages: 1. Transistorized drives require only minute current to actuate circuit. 2. Multi-channel operation with common light sources to all channels guarantees tracking to within  $\frac{1}{2}$  db between channels. 3. 4 channels or more can be driven by a single actuator. 4. Infinite resolution from 0— $\infty$ . 5. Plug-in light source allows instantaneous replacement. 6. Improved mechanical construction of slide faders' precious metal sliding contacts gives long trouble-free life, offers adjustable feel. 7. Plug-in, remote, and slide-wire models range from one to four channels and are designed with ultimate versatility in packaging.

Contact your Fairchild Recording Distributor or write **FAIRCHILD RECORDING EQUIPMENT CORPORATION**, Dept. DB-5, 10-40 45th Avenue, Long Island City, New York 11101.

Fairchild Lumitens (available in 600 and 150 ohms) include: 66811 Attenuator, 668 PAN-2 Pan Pot Actuator, 668 ACT Remote Cell Actuator, 668 ST11 Stereo Attenuator, 668 RSB Remote Stereo Attenuator, 668 MC 4-channel Master Control Attenuator card, 668 RAB Remote Attenuator packaged on compact PC card, 692 D1 Single Remote Attenuator, 692 D2 Two Independent Attenuators. Slide Wide Fader: SWL600 (600 ohm L pad).

Circle 9 on Reader Service Card

the damping liquid, or the mechanical properties of the damping material) is no longer capable of suppressing peaks of the mechanical system of the cutter.

Electrical feedback cutters which depend entirely on the feedback loop for their performance are far superior in this case, regardless of the fact that some recording experts prefer "blooming of the sound" caused by the mechanically dampened cutters at high levels.

It is also known, and has been described quite well in a number of technical papers, that there are difficulties cutting lacquer at high frequencies and high levels. Most systems are pretty marginal in the amount of power delivered at higher frequencies. RIAA or NAB pre-emphasis curves impose a further burden on the amplifier and cutter. And this happens at the frequencies where the cutter is least efficient. One of the techniques in use (described in one of my earlier columns) to ease this problem is half-speed recording. This allows better control over high frequencies, improved recording levels, over-all frequency response, and distortion. Now, this technique does not overcome the limitations imposed on the recording level by the linear speed of the groove. It only helps people with inferior recording setups achieve results obtained by more fortunate studios (without destroying the cutter).

You should never forget that the recorded groove will be played back by mechanical means, so that in some cases no matter how perfect the wave form may look through the scope, it will never be properly traced by the playback stylus.

The dimensions of the stylus and the weight of the stylus-arm assembly, along with compliance to the groove walls prevents uninterrupted tracing of high-frequency high-level groove excursions at small diameters. By applying the so-called *diameter equalization* which boosts high frequencies as the diameter of the groove gets smaller, tracing is not helped unless the recording levels are low to begin with. With today's hot records, the only way to help tracing at the small diameters is to apply equalization in reverse, cutting on high frequencies or lowering the over-all level. Many times the program material is selected to help the problem: place the disc selections containing less highs and lower levels at the inner diameter. Another factor that many forget is that linear velocity on the outside of a twelve-inch disc is close to 20 inches/sec., while the innermost grooves have a linear speed of about 7 inches/sec. The difference in speeds is almost 3/1. You don't expect your tape machine to work equally well at  $3\frac{3}{4}$  in./sec. as at  $7\frac{1}{2}$  in./sec.? In tape recording we can pre-emphasize more at the high frequencies for the slow speed, sacrificing



# Only their sound man knows for sure.



The Philharmonic they're not. Joyful noisemakers is really more like it. But that's between them, their audio engineer and the lamppost. On tape they sound strictly euphonious.

Between us, the unsung hero is the guy at the controls. Plus the compact, uncomplicated noise-elimination system with a small price tag and a big name. The Model 123 Graphic Frequency Response Equalizer.

It divides the audio spectrum into 36 critical bandwidths for matchless selectivity in separating

unwanted sounds from any program. And your program material suffers not in the least.

There's much, much more . . . like selective emphasis. Read all about it. Or better yet, hear the 123 in action. A quick call or note is all it takes.

**B & K INSTRUMENTS, INC.**  
Brüel & Kjær Precision Instruments  
5111 West 164th Street • Cleveland, Ohio 44142  
Telephone: (216) 267-4800 • TWX: (810) 421-8206

Circle 14 on Reader Service Card

[www.americanradiohistory.com](http://www.americanradiohistory.com)

on s/n but gaining in bandwidth. In disc recording, past a certain point, instead of gaining level at high frequencies, the level will drop and distortion will soar sky high.

Another pitfall many run into exists when we align the system for its optimum performance with the use of a signal generator, scope, distortion analyzer (and all the test gear you can scrounge). This is done at a level of, let us say, 4 dB above the standard level of 3.8-cm./sec. velocity. For steady tones at this level, the sound is clean from the very input to the cutting system to the output of the playback speakers. But feed program information into the system so that a vU meter reads the same level and you are due for a surprise. Peak levels of program in a broad-band system exceed an average 10-14 dB above the levels shown on the vU meter. Is your system capable of such levels? Don't try it until you carefully check with the instructions supplied by the cutter manufacturer indicating the distinct limitations of the system at high frequencies. One thing you can do is substitute a dummy load for the cutter and check what levels can be obtained before overload occurs. Do this after you measure the output of the amplifier at zero reference level so as to have a point for comparison.

How do you practically determine if

the sound on the disc is a good replica of the tape? Mount the arm with the good playback cartridge on the side of the cutting table and play back the groove as you cut it. By installing a switch to select either the output of the tape machine or the playback arm, you can a-b between the two sources and so correct for possible deficiencies of the sound from the disc.

This can be best done with equalizers. Limiters and other gain-riding devices should be left out except for the limiter set for overload protection. Once completely acceptable sound is achieved, the master disc can be cut.

This should not be played. Even a single replay using the best cartridge will smear soft acetate. Optical inspection is recommended instead. Test strike-offs can be used as a final quality check of the master. Don't forget that the ultimate vinyl pressing will sound brighter on the top end than the soft acetate. The less compliant the cartridge, the larger the difference.

The same technique of a-b test holds true for 45 r.p.m. discs, which are normally cut at higher levels, but with restricted bandwidth.

Another question often asked of me, concerns the possible distortion of the groove in the stamping process due to some factors not related to the original recording or mastering. Let us consider

the most annoying and most often encountered problem in pressing — noise. If cleanliness of chemicals, disc surfaces, and vinyl material is not observed, as well as plating currents and plating solution temperatures, the results may be anything but satisfactory. However, as far as duplication of the grooves is concerned, plating is one of the most perfect ways to accomplish the job. Errors between the original and the copy are measured in microns. The only source of measurable groove distortion is in the vinyl material itself.

In the stamping or injection processes, plastic is first heated and then fed between the two stampers, then stamped and cooled. Depending on the material and the temperatures encountered, expansion and compression of plastic varies, usually on the order of 3 to 7 per cent. When hot plastic (aside from vinyl, other materials are also used) is in contact with stamper it conforms to the size of the stamper. When the disc is cooled, it shrinks. Most of the stampers have water cooling jackets which, once the impression is made, have circulating cold water to speed up cooling of the plastic. Grooves on the stamper are actually protrusions so the vinyl impression slips off the stamper as it cools. Sometimes, if the finished discs are left to cool off while resting on uneven surfaces they may develop a warp. But the only way distortion of groove may occur is if the temperature of the plastic is too low so the plastic doesn't flow properly — producing non-fill. A chilled spot on the stamper or vinyl would make this spot of the disc noisy.

Fortunately, we don't often run across these gross rejects when buying records, because most of these faults are repetitive, and are consequently arrested at the stamping plant during the routine inspection.

## BUILDING BLOCKS TO SOUND SYSTEMS

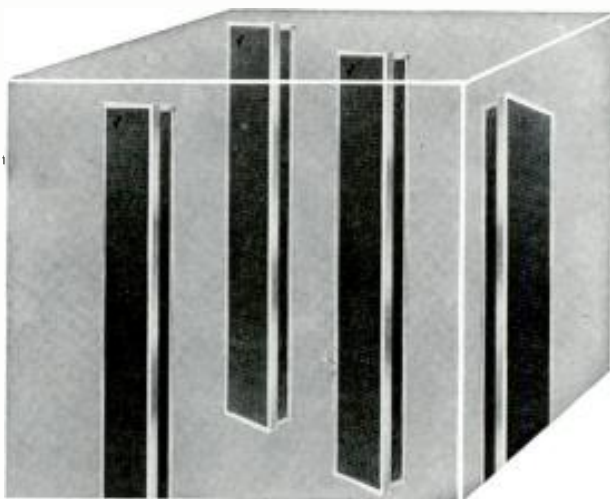

## A complete line of Indoor and Outdoor Sound Columns—to beam sound exactly where you want it

Sound Column's bicone speakers create a flat, fan-shaped beam of sound that can be aimed as required with great accuracy—quality audio is easily distributed even in very noisy surroundings  Reverberations and echoes are more easily controlled or eliminated  High fidelity audio coverage over the full frequency range from 60 Hz. to 18 KHz.  Fine, rich reproduction of

music  Handsome birch or walnut veneer cabinets available  Adjustable brackets for mounting to wood, masonry, concrete or steel  Write for "Sound Column" applications bulletin to the innovators.

**PHILIPS** PHILIPS BROADCAST EQUIPMENT CORP.  
One Philips Parkway, Montvale, N.J. 07645 • 201/391-1000  
A NORTH AMERICAN PHILIPS COMPANY

## BACK ISSUES AVAILABLE

A limited number of back issues of db are available to interested readers who may have missed or misplaced earlier issues. When ordering please indicate date of issue desired and enclose 75c for each copy.

CIRCULATION DEPARTMENT  
db—The Sound Engineering Magazine  
980 Old Country Road  
Plainview, N.Y. 11803

Circle 18 on Reader Service Card

# AUDEX™

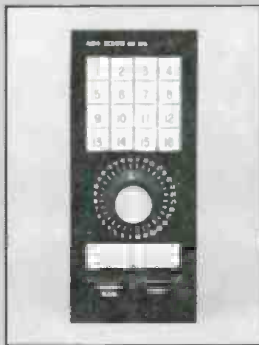
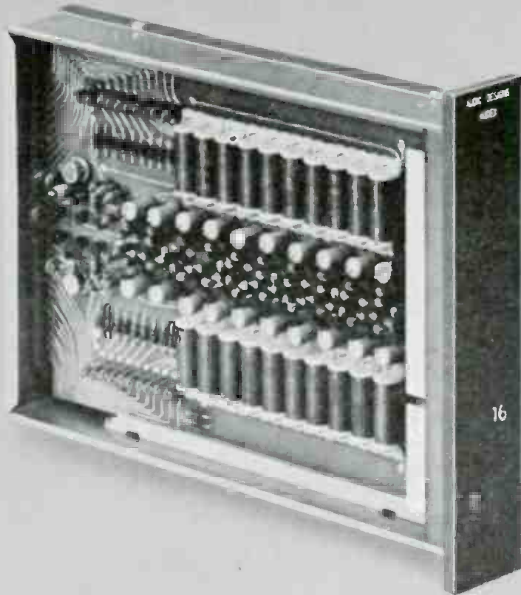

The ALL-NEW, COMPACT Audio Switchers and Switching Control from Audio Designs that solve the complexity of buss assignment and matrixing of multi-channel consoles.

Button, button, whose got the button? Finally here's an audio component that will simplify your console programming . . . a system that will replace up to 640 buttons. Using the Audex control you may switch up to 32 Audex plug-in modules. With Audex I & II you can separately switch up to 16 program busses and 4 echo busses; whereas Audex I is a self canceling switcher, Audex II will simultaneously connect an input to 16 program and 4 echo busses. Audex III will simultaneously matrix up to 20 program channels to a single output making it ideal as a mix down or monitoring matrix. So one control panel times 32 modules times 20 channels per module equals 640 missing console buttons. Besides the ease of operation, consider the savings in console panel space. The switching is noiseless with life in excess of 10,000,000 operations. To learn all about the new Audex system or our other modular components, simply write or call . . .



AUDIO DESIGNS / 15645 Sturgeon / Roseville (Detroit), Michigan 48066 / (313) 778-8400

Circle 22 on Reader Service Card.

[www.americanradiohistory.com](http://www.americanradiohistory.com)

# The Feedback Loop

ARNOLD SCHWARTZ

● It wasn't planned that way, but there are houses in the vicinity of New York's La Guardia Airport so close to the runways that landing approach lights are literally in someone's backyard. The introduction of jet aircraft and the development of previously open land adjacent to the airport into high-density residential neighborhoods have created a complex community noise problem. In last month's FEEDBACK LOOP we had a background discussion of noise problems and acoustical measurement techniques. This month we will discuss how a particularly acute noise problem is being handled.

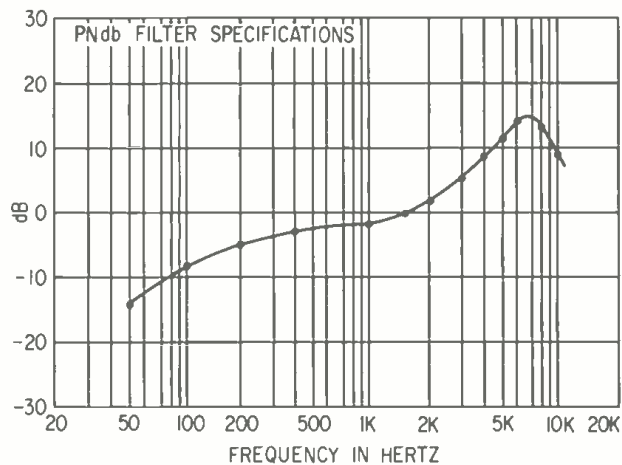

Figure 1. The PNdb weighting curve.

## BUILDING BLOCKS TO SOUND SYSTEMS



## The PRO 12 Tape Recorder: industrial reliability, studio performance

The PRO 12 deserves your special consideration. It is the finest new portable professional tape recorder on the market  Solid state  Portable/Compact  Twin-track mono; dual half track; stereo models  Special version for four-track mono and stereo  Semi-servo speed control  Mixer/Preamp with three inputs for each channel  Built-in facilities for mixing two inputs  Test switch for lineup  Multi-play and Sound on Sound recording  Switchable monitoring of recording signal dur-

ing recording—Before and After tape  Built-in monitor amplifier with loudspeaker  Stereo headphone monitoring  Cue and dubbing facilities  Tape-lifters  End-of-tape and tapebreak switch  Pause button  Remote control facilities  For full data, contact the innovators.

**PHILIPS** PHILIPS BROADCAST EQUIPMENT CORP.

One Philips Parkway, Montvale, N.J. 07645 • 201/391-1000  
A NORTH AMERICAN PHILIPS COMPANY



Figure 2. A remote monitor station operated by the Port of New York Authority at the airports they operate.

Circle 17 on Reader Service Card



# SOUND BOOSTER

## FOR ARENAS CARNIVALS COLISEUMS CATHEDRALS AUDITORIUMS AMPHITHEATRES

*You name it - we guarantee it!*

**The Audimax.** Whatever your sound reinforcement requirements, this remarkable instrument fills the bill...*automatically.*

Especially effective for use with non-professional speakers or actors. Compensates for speaker-to-mike distances. Automatically controls audio levels - to boost your signal when your speaker has a tendency to drop his voice. Helps even a soft-voiced amateur "speak up" like a pro!

What's more, the Audimax works without distortion, thumping, pumping or audio "holes." Bridges through program pauses without "swish-up" of background noise. Delivers a smoother, more pleasant sounding performance...from front row to back row (balcony, too!). Anywhere in your audience!

*Try it FREE for 30 days.* No obligation. No strings attached. If you don't like it, send it back. Freight's on us. If you like what you hear, send us just \$665.

Small price to pay for the best level control in the business!



PROFESSIONAL  
PRODUCTS

**LABORATORIES**

Stamford, Connecticut 06905  
A Division of Columbia Broadcasting System, Inc.

Circle 21 on Reader Service Card

[www.americanradiohistory.com](http://www.americanradiohistory.com)

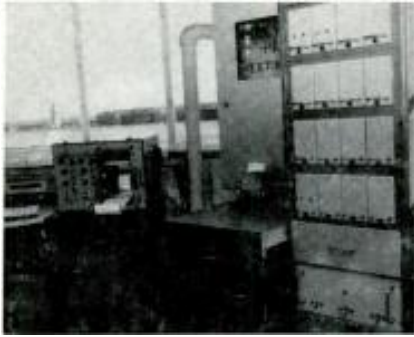

Figure 3. The central noise-control tower at La Guardia Airport.

## BACKGROUND

Since 1951, the Port of New York Authority, a bi-state public agency which operates La Guardia, Kennedy, and Newark airports, has been vitally concerned with the disturbance to residential neighborhoods caused by aircraft noise. In 1953 the Port Authority retained Bolt, Beranek, and Newman (BB&N) as consultants to study and advise on aircraft noise problems. BB&N made an extensive analysis of

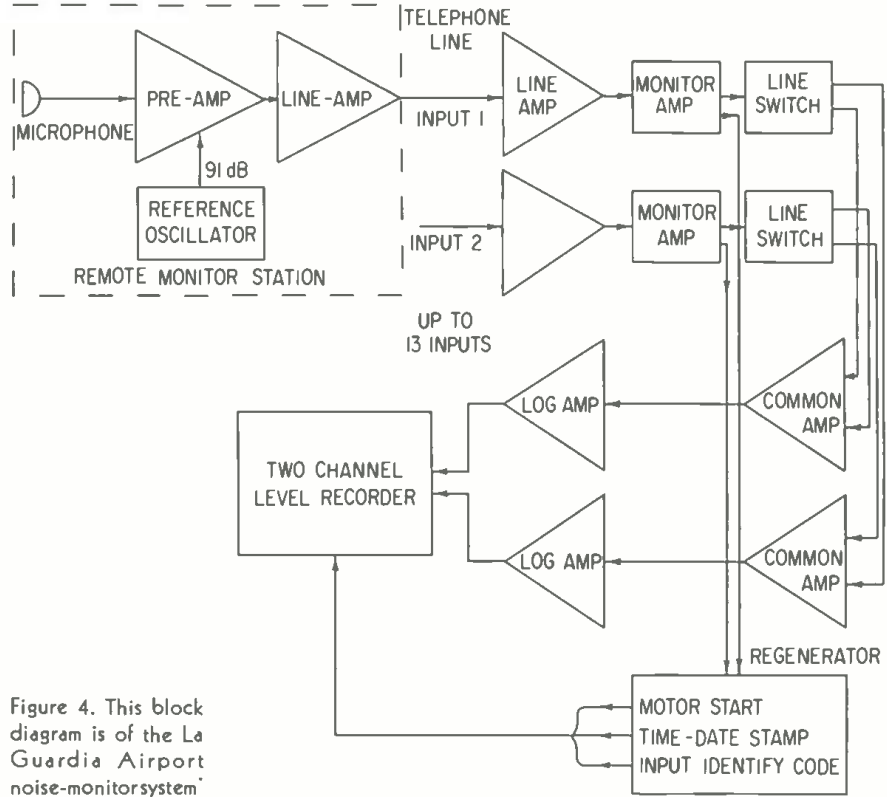
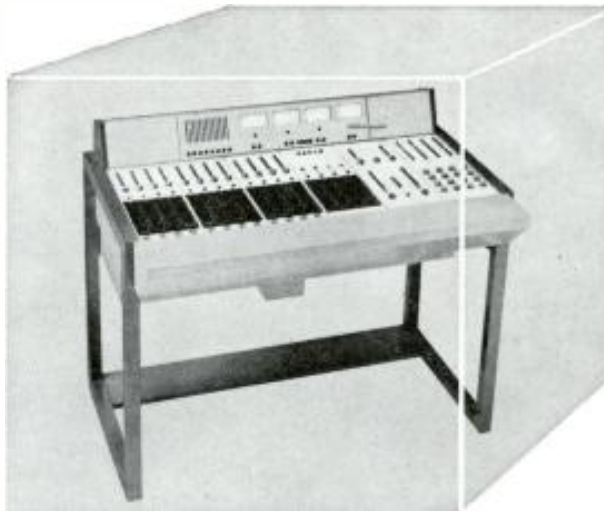

Figure 4. This block diagram is of the La Guardia Airport noise-monitoring system.

## BUILDING BLOCKS TO SOUND SYSTEMS



## Third-Generation Mixing Desks... compact and flexible, realistic pricing.

□ Philips MD Series Mixing Desks are designed for recording, radio, TV, film and theatre use □ They have exceptional operational features with outstanding specifications and a price-to-performance ratio unmatched in the industry □ Solid state □ Flexible, easily-serviced design based on modular system □ Maximum of 24 inputs to 12 input channels □ Up to 4 independent output channels (for stereo and multi-

track recordings) □ Current-dependent mixing □ Monitoring and pre-listening provided □ Optional equalizer module, with 4 equalizers, switchable to 8 input channels □ For full data, contact the innovators.

**PHILIPS** PHILIPS BROADCAST EQUIPMENT CORP.  
One Philips Parkway, Montvale, N.J. 07645 • 201 / 391-1000  
A NORTH AMERICAN PHILIPS COMPANY

jet noise and of piston-aircraft noise using measurement techniques similar to those discussed last month. This investigation produced the concept of *perceived noise decibels* (PNdB). This is a weighting curve which approximates the subjective annoyance (on the ground under the flight path) of jet aircraft noise. FIGURE 1 shows the PNdB weighting curve. Below 1,000 Hz, the PNdB curve resembles the A weighting curve used in sound level meters. Above 1,000 Hz the PNdB curve is sharply peaked emphasizing the high frequency range, while the A weighting curve is attenuated in that region. The A weighting curve is an approximation of the ear's *sensitivity*, and it reflects the loss in sensitivity at low and high frequencies. The PNdB weighting curve is an approximation of the subjective *annoyance* of jet-aircraft noise; the low-frequency attenuation and the high-frequency emphasis reflects the relative annoyance of the various frequency components of jet noise.

The concept of PNdB is the basis for the establishment of maximum noise levels. In 1958 the Port Authority decided that jet-aircraft operations should be "so planned and conducted that noise in the communities under the take-off path, expressed in PNdB, was [to be] no greater than the noise pro-

Circle 16 on Reader Service Card

duced by 75 per cent of the large four-engine piston transports as measured in the community under the take-off path. That value, which proved to be 112 PNdB, was adopted. . . . as the limit for jet noise and is still in effect today."

Enforcement of the 112 PNdB noise limit is the Port Authority's basic method of controlling jet noise on take-off. In order to be eligible to use La Guardia, Kennedy, or Newark airports, the airlines must limit take-off noise to this maximum. It is left up to the individual carrier to devise methods of compliance such as steep climb, thrust reduction, turn away from the community, limitation of gross weight, or the more basic approach of designing quieter jet engines.

## NOISE MONITOR SYSTEM

In order to ensure compliance with the 112-PNdB maximum, the Port Authority, in conjunction with BB&N, devised, constructed, and installed an elaborate noise-monitoring system at each airport they operate. This system, which automatically records all take-off jet noise, has made it possible to enforce the 112 PNdB maximum. Joe Frederickson, aeronautical planning specialist of Aviation Technical Services Division, arranged for a helicopter to take us out to La Guardia Airport to see the noise monitoring system in operation.

## SYSTEM DESCRIPTION

The airport noise monitoring and control systems monitors aircraft take-off noise on all runways that require the aircraft to fly over residential neighborhoods. The basic element of the system is the remote monitoring station. Joe Frederickson showed me a typical station (see FIGURE 2) which consists of a telephone pole with a microphone and associated electronic equipment mounted at the top. The station is located in line with the runway at the start of the residential area. The proximity of homes to the monitor station can be observed in the photograph. Distances of these stations from the start of the runways varies from 2 to 4 miles and a telephone line connects the remote station to the central noise-control tower.

The noise-control tower is located so that all take-offs can be observed by an operator on duty. The tower is manned 24 hours a day, and all take-offs are logged by the operator. As the aircraft approaches the remote monitor station, and if the sound pressure level is greater than 96 dB, the noise monitor system is activated. All pertinent noise data is recorded on a graphic level recorder shown on the left side of the photo of FIGURE 3. This photograph was taken looking out on to the runway area from the operator's position in the noise-control tower. The operator also

records the PNdB level in a log, shown to the left of the level recorder. If a violation occurs the pilot is notified immediately, and the airline is sent a written notification of the violation which initiates the compliance procedure.

## SYSTEM FUNCTION

A block diagram of the La Guardia noise monitor system is shown in FIGURE 4. A close-up photograph of the remote monitor station (FIGURE 5) shows the microphone mounted with its axis parallel to the ground so that the sound impinges at grazing incidence, minimizing the diffraction boost, and yielding the flattest frequency response. A hydrophone is actually used because of

its immunity to rain and damp weather. The metal screen enclosing the hydrophone acts as an electrostatic shield. The pre-amplifier amplifies the microphone signal and is also used to insert a reference oscillator signal at a level equivalent to an SPL of 91 dB. An amplifier drives the 600-ohm telephone line which terminated in the control tower. The incoming signal at the tower is fed to a line amplifier and then into a monitor amplifier, both of which are housed in the equipment rack shown on the right hand side of FIGURE 3. It is possible for more than one signal to be present at any instant. A line switch controlled by the monitor amplifier determines which of the two recording channels is to handle an incoming signal. The monitor amplifier also performs the



**"The Dolby system gives me a 10 db reduction of hiss, print-through and crosstalk,"**

says Seymour Solomon, recording director of Vanguard Records. "The use of the Dolby Noise Reduction System enables us to record a work with great dynamic contrasts, such as the Mahler 2nd Symphony, with a new dimension of realism. It is now standard procedure to record our Vanguard classical tape masters with the Dolby System."

Take a tip from Mr. Solomon—break through the noise barrier with the dependable Dolby A301, now in use by over 90 companies throughout the world.



The Dolby A 301

## DOLBY LABORATORIES INC.

333 Avenue of the Americas, New York, N.Y. 10014 □ Telephone (212) 243-2525 □ Cable: Dolbylabs New York

<p><b>So. CALIF.</b> Audio Industries Corp. 1419 N. LaBrea Ave. Hollywood, Calif. 90028 Tel. 213-HO 5-4111</p>	<p><b>No. CALIF.</b> Audio-Video Systems Engineering 1525 Tennessee Street San Francisco, Calif. 94107 Tel. 415-647-2420</p>	<p><b>MIDWEST</b> Expert Electronics Inc. 7201 S. Western Avenue Chicago, Illinois 60636 Tel. 312-HE 6-2700</p>	<p><b>CANADA</b> J-Mar Electronics, Ltd. 6 Banigan Drive Toronto 17, Ontario, Canada Tel. 416-421-9080</p>
--	--	---	--

Circle 20 on Reader Service Card

**buy one  
FULL  
8-track  
recording  
console—  
and get  
two FREE!\***

**\*Well, not exactly. You probably only need one system anyway. But, we're prepared to sell it to you for 1/3 less than anyone else.**

**P.S. Our quality and performance standards are not on sale.**



**QUAD-EIGHT  
ELECTRONICS**

11810 VOSE STREET, NORTH HOLLYWOOD  
CALIFORNIA 91605 • PHONE (213) 764-1516  
Circle 15 on Reader Service Card

important function of acting as a gate by sensing the signal level and allowing only signals to go through which exceed the preselected SPL of 96 dB. When the gate is open the monitor amplifier will direct the line switch to connect the signal to the preferred channel; if it is busy the signal will be switched to the other channel.

The output of the line switch feeds the common amplifier. A perceived-noise filter then introduces the weighing factor (FIGURE 1). From this point on the signal is referred to as PNdB. The PNdB signal is fed to a logarithmic amplifier, located in the graphic level recorder which supplies a d.c. output proportional to the logarithm of the amplitude of the incoming signal, and so converts the signal to decibel readings. The d.c. signal is fed to the graphic level recorder, and the recording stylus indicates the PNdB level on a chart.

At the same instant that the signal is being fed to the recorder, the monitor amplifier feeds the signal to the regenerator causing a relay to close which actuates a time and date stamper. The stamper mechanism can be seen in the close-up photograph of the level recorder in FIGURE 6 as an outboard device protruding from the level recorder immediately above the chart. The relay closing also starts the recorder chart motor. Simultaneously with the starting of the motor the identification equipment is made operative so that the incoming signal can be identified. A series



Figure 6. The graphic-level recorder used to preserve the aircraft sound measurements.

of coded marks is recorded on the chart along with the PNdB level. The recorder will run as long as the noise level is greater than 96 dB plus an additional 20 seconds. The 20-second delay is used to permit the recording of the 91 dB calibration tone which, as we have seen, is always present at the remote station pre-amplifier but is normally below the level required to open the monitor-amplifier gate. All the necessary information is now recorded on the chart which is kept as a permanent record.

The noise control system instituted by the Port Authority at the three metropolitan airports has proved highly effective. Pete Odell, assistant chief of Aviation Technical Services Division, told me that compliance today is *better than 99 per cent*. I was surprised to learn from him, however, that the airports under the Port Authority's jurisdiction are the only airports in the United States with an established noise maximum and an effective enforcement system. Recent Federal legislation has given the F.A.A. authority to set noise standards for aircraft so it may not be too long before other airports have noise standards established. The experience and knowledge gained by the Port Authority will certainly prove invaluable in setting up future Federal regulations.



Figure 5. This close-up of a remote monitor station such as in Figure 2 shows the microphone to be parallel to the ground so that sound impinged on it in a grazing fashion.

## MOVING?

Have you sent us a change-of-address notice? It takes time for us to change your plate so let us know well in advance of your move. Be sure to send us the complete new address *as well as your old address*. Include both zip numbers. Keep db coming without interruption!



**When low distortion is a critical requirement,  
Acoustic Research speaker systems are a logical choice.**

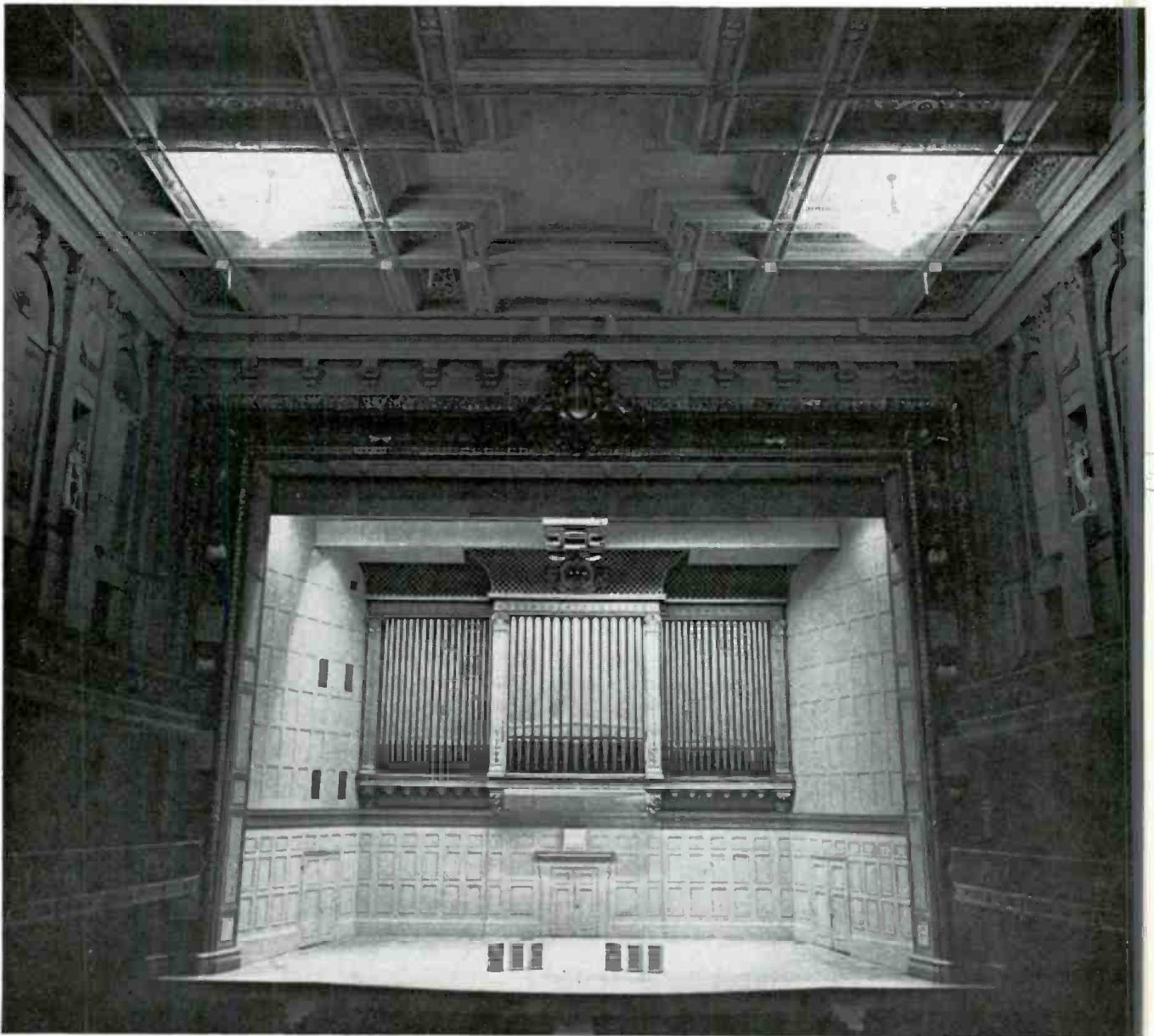

Acoustic Research speaker systems are carefully designed and meticulously inspected to be certain that they reproduce sound while introducing no sound of their own. This lack of distortion partly explains their natural, uncolored music reproduction in rooms both large and small, of delicate harpsichord tones or the tutti of a Beethoven symphony. As at a concert, the listener hears what the musicians have created, free of unnatural artifice or misguided attempts at enhancement.

At a recent performance of *Deserts* by Edgar Varese, a work for stereophonic magnetic tape and symphony orchestra, the Boston Symphony Orchestra was accompanied by six AR-3a speaker systems reproducing the composer's tape. The requirement was authenticity of reproduction without distortion of the acoustical setting provided by Boston's Symphony Hall, which Bruno Walter called "the noblest of American concert halls." The speaker systems are shown on the stage during tests.

AR-3a speaker systems are priced from \$225 to \$250, depending on cabinet finish. Write for complete technical data and an AR catalog describing our other speaker systems, turntable and amplifier.



**Acoustic Research Inc.**

24 Thorndike Street, Cambridge, Massachusetts 02141

Overseas Inquiries: Write to AR International at above address

*Circle 19 on Reader Service Card*

[www.americanradiohistory.com](http://www.americanradiohistory.com)

# NOW, THE STUDIO CONSOLE WORTH WAITING FOR

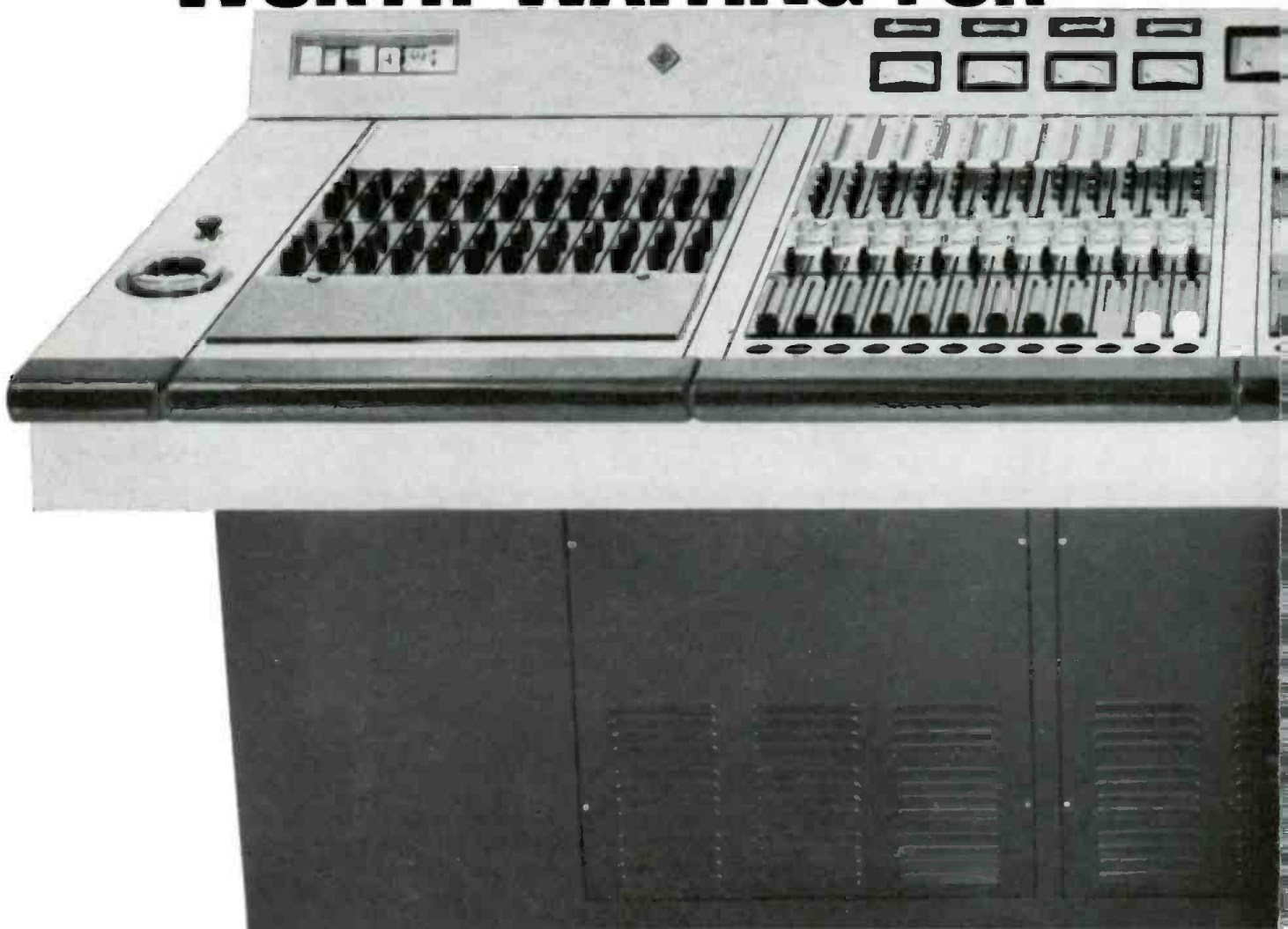

A lot of very fine consoles are being produced these days. Slowly.

Expensively.

With agonizing attention to detail.

And a lot of time spent waiting.

We want to help. That's why we've come up with the first studio console you can have in a week.

A console with all the important features you'd specify if you were having it custom made.

But without the waiting. The headaches. And the custom-made price tag.

It's designed and built for us by Neumann, the finest name in audio equipment. A name that not only means quality and experience, but technical excellence and high resale value. And you know it measures up to Gotham's rigorous standards. Because we don't have to deal with anything less than perfect.

The Neumann studio console has twenty-four inputs and eight output channels, and can be augmented to sixteen. It meets every studio requirement you can imagine. And some you probably haven't even thought of.

*Circle 23 on Reader Service Card*

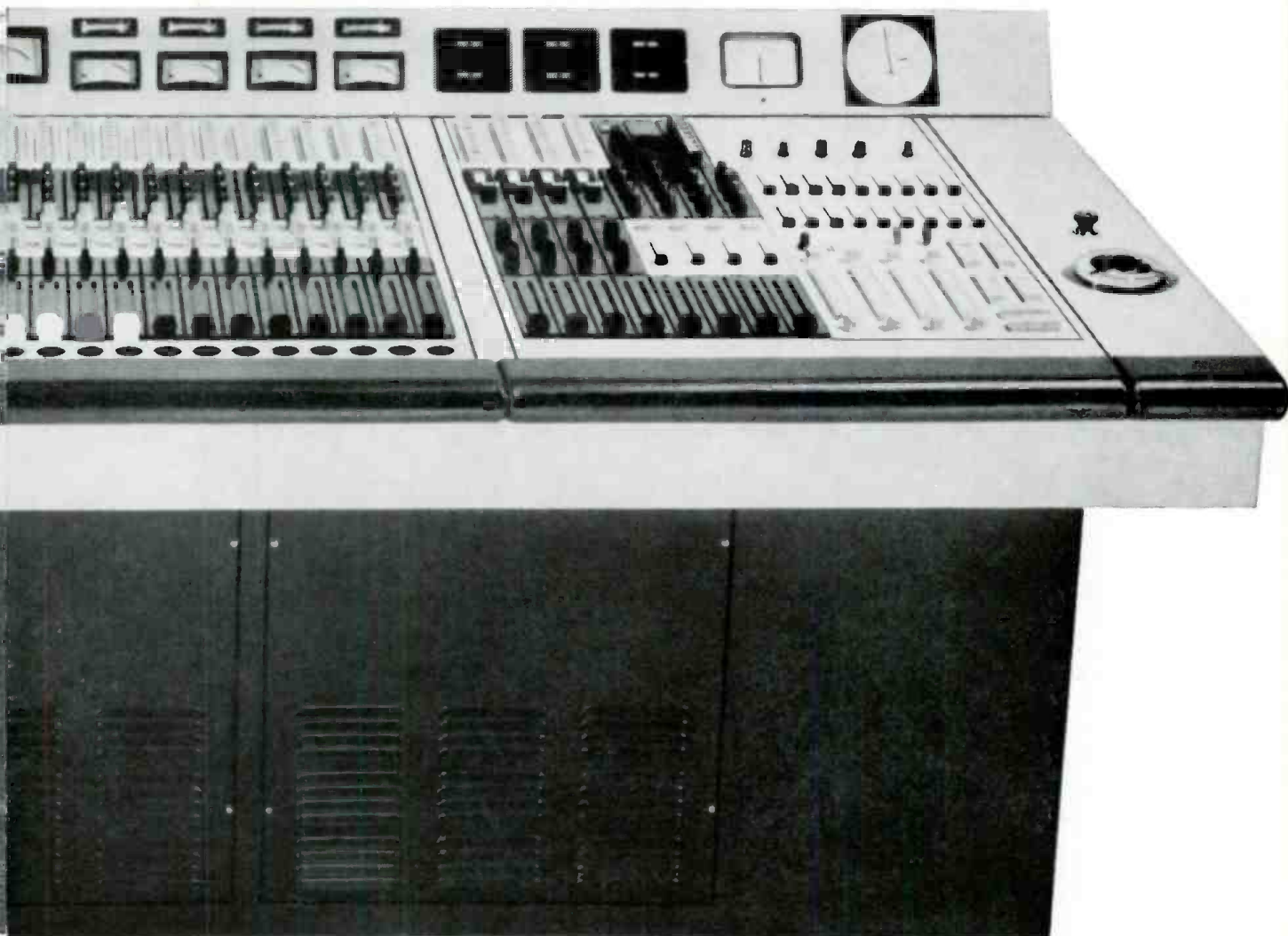

## CAN BE DELIVERED IMMEDIATELY.

Consider these: 24 pan-pots, 2 cue and 4 echo channels, 4 remote echo controls, 4 remote tape controls, talk-back limiter, day-date-time digital clock, stop timer, U-79 Correlation Meter (Compatibility Guide), full 312 jack patch bay and phantom powering for your Neumann FET-80 microphones.

Even built-in ashtrays and cigarette lighters.

This remarkable piece of equipment costs under \$64,000, because we've been able to amortize the immense engineering and design costs over many consoles instead of just one.

And you'll be earning back a large share of your investment months earlier, simply because of Gotham's speedy delivery. After all, a console in the control room is worth *ten* on the drawing board!

So, phone us today. You can be turning out hit sessions by next Monday.

**GOTHAM**

AUDIO CORPORATION  
2 West 46th Street, New York, N. Y. 10036 (212) CO 5-4111  
1710 N. LaBrea Ave., Hollywood, Ca 90046 (213) 874-4444  
In Canada: J-Mar Electronics Ltd.



# Editorial

**A**T A RECENT New York City concert, Laurin Hollander played an experimental piano built by the Baldwin Company. Inside the piano, the usual sounding board was replaced by a battery of JBL speakers. A modified Marantz amplification and control system was used internally to adjust the piano's tone to musical and environmental conditions at hand. Esthetically, the concert was a success.

Of course, this was by no means the first electronically amplified instrument. Electronic control of guitars is already highly sophisticated and most other instruments have been electronically modified to some extent. In addition, a totally new breed of instrumental sound has been created by the electronic synthesizer.

Obviously, an electronic piano that frees the performer from the instrument's present limitations is highly desirable. But is the raucous distortion of electronic guitars also acceptable? We think so. . . as a necessary (even pleasant to some) by-product of a vital and creative new musical era.

These electronic instruments can be totally new music-making forms. The synthesizer is currently shaking up the serious music field and modified guitars have transformed pop music. So, we look forward with interest to the potential of this new piano.

Where does the engineer fit into the rapidly expanding field of engineered music? Should we merely amplify — and possibly alter as well — existing musical sounds? Or should our approach be to help create a new musical medium that carries a message all its own?

We do not see any musical or artistic validity in amplification *per se*. We frankly wish the whole loudness race — whether for higher modulation on records or 130 dB levels in discotheques — would just quietly fade away.

But musical production cannot be bound by the trap of tradition. (And we do not even agree with those who argue that electronic music production is contrary to tradition.) If we held only to tradition, Laurin Hollander would have been playing a clavichord.

The continuing viability of music — pop or classical — demands perpetual experimentation with new forms. And we hope the audio engineer will be in the forefront of this electronic music phenomenon. . . guiding it, growing with it and, above all, enjoying it.

L.Z.

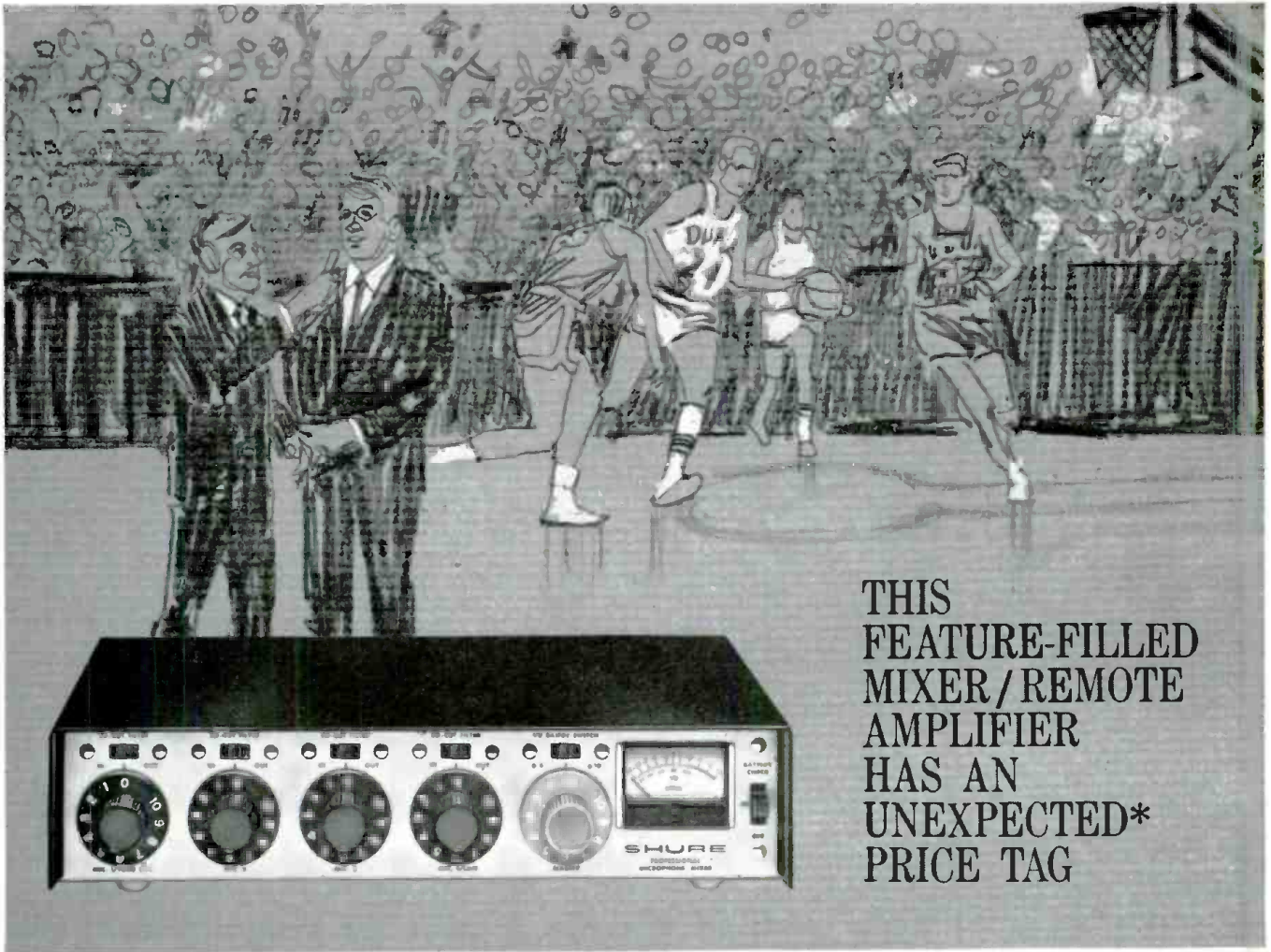

**THIS  
FEATURE-FILLED  
MIXER/REMOTE  
AMPLIFIER  
HAS AN  
UNEXPECTED\*  
PRICE TAG**

\*Unexpected? Judge for yourself: the Shure M67 Professional Mixer/Remote Amplifier has virtually every important feature asked for by broadcasting and recording studios and sound installers. It can be used as a complete, compact console for studio, remote, or original installation use—or as an “add-on” mixer for expanding existing facilities and providing additional microphone inputs with tape recorders and VTR’s.

It features 600 ohm line and microphone level outputs; an illuminated VU meter calibrated for +4 and +10 dbm; four low impedance microphone inputs, each with individual low-frequency filter inputs—plus one input convertible for line bridging, or 600 ohms; built-in tone oscillator to provide calibration signal to set signal levels; extremely low noise

and RF susceptibility (noise level -126dbv); female Cannon connectors, two-level headphone monitor jack and many other features.

Its distortion level is UNDER 1% from 20 to 20k Hz at +10 dbm out! Clipping level is +18 dbm. It also features a unique *noiseless* automatic switchover to battery if the AC line fails. (Battery pack optional.)

It is not much larger than two cartons of cigarettes (11 $\frac{3}{8}$ " x 7 $\frac{1}{2}$ " x 2 $\frac{1}{2}$ " ) and weighs just 4 lbs. 4 oz.

Incredibly, this truly professional, compact, complete mixer/remote amplifier has a professional net price of only \$147.00!

Write Professional Products, Shure Brothers, Inc.  
222 Hartrey Ave., Evanston, Illinois 60204

**SHURE M67** new  
PROFESSIONAL MICROPHONE MIXER/REMOTE AMPLIFIER

© 1968 SHURE BROTHERS, INC.

**OTHER SHURE PROFESSIONAL MICROPHONES... FOR SUPERIOR AUDIO**



**MODEL SM5  
CARDIOID BOOM DYNAMIC**

Because its cardioid directional pattern is uniquely uniform with frequency and symmetrical about its axis, the SM5 is singularly independent of the effects of environment. Even in extreme shooting situations (such as with tight sets, low ceilings, hard walls, low microphone angles, traffic or air-conditioner noise and rumble and changing distance) the SM5 minimizes sound coloration and ambient noise pickup.



**MODEL SM76  
3/4" OMNIDIRECTIONAL  
DYNAMIC**

Ideal for interviews and audience participation, yet unusually smooth wide range response (40-20 KC) for critical music reproduction. Instantly detachable from stand. Steel case with Cannon connector.



**MODEL SM50  
OMNIDIRECTIONAL  
DYNAMIC**

Self-windscreened and pop-free for news, sports, remotes, and interviews. Also ideal for many studio and control room applications. Comfortably balanced for hand or stand use. Natural response.

Circle 24 on Reader Service Card

www.americanradiohistory.com

# Tape Delay Systems

JOHN M. WORAM

Most recording studios enhance their originally-recorded dry tracks with some form of artificial or natural reverberation. The author reports on one such, using forms of tape delay to achieve the needed sound.

**M**OST MODERN RECORDING STUDIOS have some sort of echo or reverberation facility available. The most common types are; an actual echo chamber (*i.e.*, a highly reverberant room containing at one end a loudspeaker, and at the other a microphone), an EMT or similar steel sheet-type unit, a Fairchild Reverbertron, or a spring-type device such as the Fisher Spaceexpander. These devices all receive their input from an Echo send circuit in the console, and return their outputs to the console's echo return lines.

In many cases, a more natural type of echo effect may be realized if a delay is introduced between the direct signal and the echo return. The delayed echo is a closer approximation of a natural concert hall type of reverb than a return that coincides in time with the direct signal.

This delay is commonly accomplished by inserting an auxiliary tape recorder in the echo send line. The delay introduced is the time it takes for the recorded tape to travel the distance between the record and the playback head (FIGURE 1). This application of tape delay has become so popular that

many new consoles incorporate a special set of plugs for an auxiliary tape machine, and include a delay in/out switch on the console.

The popularity of this system has somewhat obscured the many other interesting applications of tape delay. To cite one obvious example: try inserting a tape delay in the echo return line instead of (or in addition to) the one in the send line. Or, when using an EMT with two outputs, one can be returned direct and the other through a tape delay. (FIGURE 2).

For a special effect, tape delay can be used without the echo device. Depending on the speed of the auxiliary tape-delay machine, two distinct effects may be obtained. At speeds which produce a delay of more than about 25 milliseconds, the delayed information is heard as a separate signal, resulting in a *slapped back* type of effect. If the signal is delayed twice, and both delays are returned to the console, there will be an impression that the instrument being treated this way is playing triplets. (FIGURE 3.) This is often particularly effective on a fender bass track, if the original bass line is not musically complex.

At delays of less than 25 milliseconds, the ear is usually unable to resolve the delayed and the direct signals into two separate and distinct sounds. For an interesting application of a high-speed delay, try feeding a direct signal onto, say, the left track during a re-mix session. The delayed signal is then treated as a separate source, and fed to the right track as in FIGURE 4. Both the direct and the delayed signals may be individually equalized, compressed, echoed, etc. The re-

*With this article, Mr. Woram begins what will be a more or less regular series of feature articles to appear in our pages. He will range widely within the recording field. He is well-qualified for this, his position as a recording engineer with RCA Victor in New York City offers him much opportunity to observe the contemporary scene.*

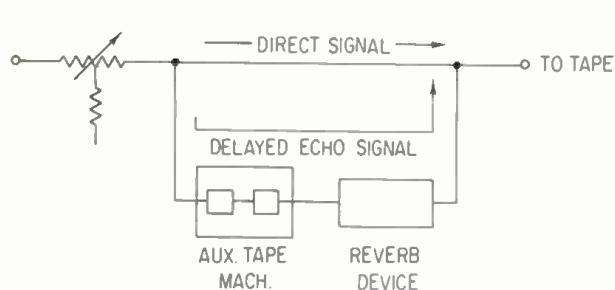

Figure 1. In this example the delay is the time it takes for the recorded signal to get from the record to the playback head.

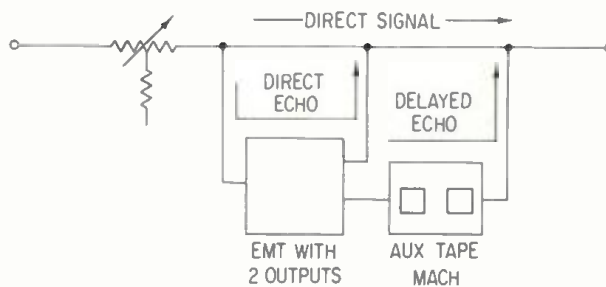

Figure 2. With an EMT system you can use one output direct and the other through a tape delay.

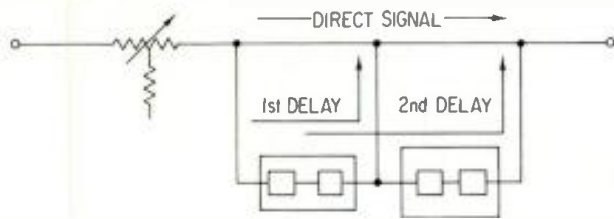

Figure 3. Two tape delays can produce an effect of triplets — most useful with certain types of bass music.

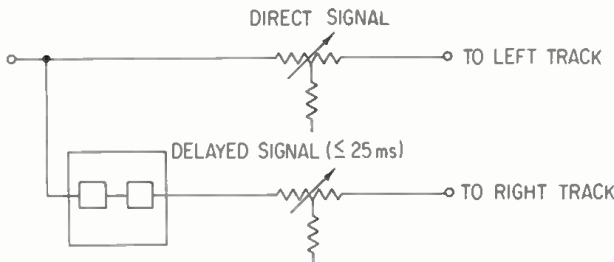

Figure 4. This system when mixed can result in greatly expanded sound — most effective with strings.

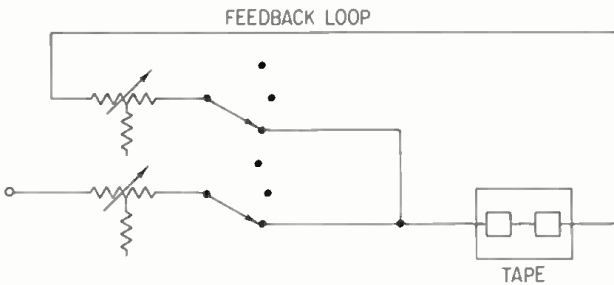

Figure 5. By controlling the amount of feedback, voice can be given an outer-space quality.

sult is a greatly expanded, room-filling sound, which can be very effective when applied to a sustaining part such as a string track; or a few voices can be made to sound like a large choir, since the short tape delay is very much like that slight imprecision of attack characteristic of a large group of voices. (If the effect is one of a *small* group with a bad case of the stutters, the tape-delay machine is not going fast enough.)

On a typical Ampex 300-type deck, the record and playback heads are about two inches apart. At 7.5, 15, and 30 in./sec., this yields delays of 266, 133, and 66 milliseconds respectively. To achieve a delay of under 25 milliseconds, an oversized capstan sleeve, such as the type used for high-speed duplicating, may be used. (In a future article, I hope to be able to give a report on the EMT 970 Audio Delay Unit, which can be used in place of a regular tape recorder for delay effects.)

An outer-space effect is possible by using a type of controlled feedback system. A signal such as a voice, is fed in the usual manner to the tape recorder. Then the playback head output is returned to a separate mixer position which is set to the same bus as the vocal mixer. By carefully riding this additional mixer, a repetitive signal is produced which can be sustained or diminished as desired (FIGURE 5).

If there is an extra track available on a multi-track tape machine, (there almost never is) a kind of negative tape delay can be used to produce an echo *before* the direct signal is heard. The program to be treated in this way is recorded on two tracks. During playback, one track is monitored in the

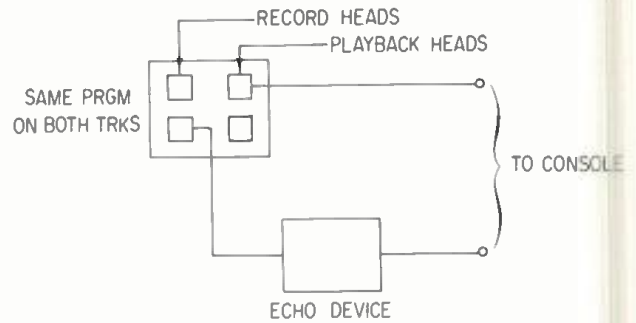

Figure 6. Using sel-sync on a duplicated extra track in this manner provides an echo before the direct signal.

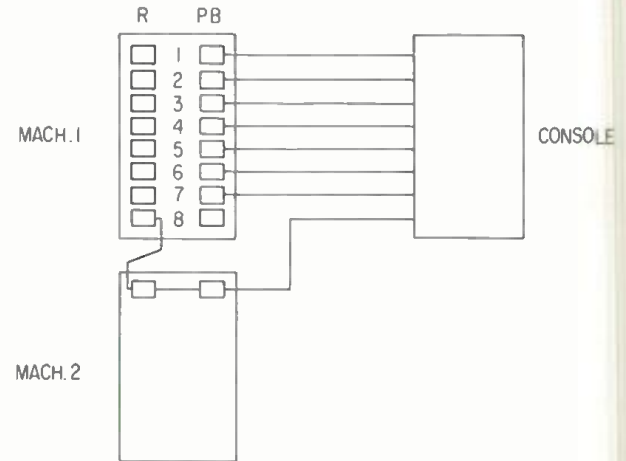

Figure 7. Vary the speed of machine two if you want some truly unusual effects. If you are feeding in the vocal part only, you can make it race ahead or fall behind the rest of the program.

usual manner. The other track is switched to the sel-sync mode, so that the output is taken from the record head, and then sent directly to the echo device. The echo return arrives at the console before the actual program, producing a very unusual effect (FIGURE 6).

Another odd effect can be produced by varying the speed of the auxiliary tape-delay machine. While the machine is changing speed, the pitch of the echo signal will rise (or fall) and then return to normal as the machine stabilizes at the new speed. Of course, the direct signal remains unaffected.

A somewhat devastating effect can be achieved if you have available, say, two eight-track machines of the same type. With a previously recorded tape, try playing back the instrumental tracks only from the playback head. At the same time, feed the vocal track from its record head to the second machine, monitoring the vocal track from the second machine's playback head as shown in FIGURE 7. As long as the two machines are running at the same speed, everything sounds fine. But try varying the speed of machine two and hear what happens as the vocal part races ahead or falls behind the rest of the program! You probably won't have much chance to apply this effect, other than as a practical joke.

The application of tape-delay systems to produce a variety of unusual effects is limited only by the flexibility of the console and the imagination of the engineer. If you have any original applications that you think might interest others, send them in.

# U. S. Senate Sound System

This is a preliminary report on a new sound amplification system to be installed for the benefit of U.S. Senators who have, up to now, had to depend solely on lung power in the Senate chamber.

VISITORS TO THE SENATE GALLERIES will receive the dubious dividend of sound as well as sight in the near future. The Senate Rules Committee has approved the installation of an intricate sound system in the Senate chamber, and following approval of the Senators, the system will be installed whenever the Senate is not in session.

For years visitors, members of the press, and some members of the Senate viewed the proceedings of the Greatest Deliberative Body in the World as though they were watching a silent movie being shot on location. Booming Senatorial voices that filled the TV screens in Keokuk were barely audible to the tourists in the galleries.

Now, with tradition tossed to the winds, the marvels of electronics will bring the amplified orations of the 100 Senators to the ears of all.

The Senate has long opposed the invasion of electronic devices in its hallowed chamber. Senator Javits (NY) had the affrontery to introduce such legislation in 1957. It got nowhere. In 1967 the Legislative Reorganization Act included amplifying equipment for the Senate. The bill passed the Senate, but died in the House—where microphones have been in use for years. In calling for installation this year, Senator Javits suggested that the modern devices could well blend with the traditional, in that the historical inkwells on each Senator's desk could be topped by a microphone instead of a quill pen.

The change was discussed at a Democratic caucus early this year and was overwhelmingly approved. Senator Mansfield says the microphones will be installed—possibly by the end of this year.

A survey made at the direction of the Architect of the Capitol by acoustical consultants has recommended installation of individual desk-mounted microphones and miniatur-

---

*We are grateful to Congressman John W. Wydler of the Fourth District, New York for his help in securing this information. The article is a reprint that originally appeared in the Congressional newspaper ROLL CALL dated March 13, 1969.*

ized loudspeakers for all Members, speakers for the Presiding officer and Senate officials, a removable floor-stand microphone, loud-speakers for the official reporters, and a wide distribution of loudspeakers in the Galleries.

Cost of the installation is estimated at \$125,000.

Under consideration is a plan to block off a small part of the Visitors Gallery behind a plexiglass screen to cut down on background noise. This section, which would contain no seats, would be used for tourists on guided tours who move in and out of the galleries. Tourists who want to watch the proceedings at greater length would be required to obtain regular admittance cards from their Senators or Representatives, as is now the case.

The system would be controlled by a person manning a console in one corner of the chamber who would flick the mikes off and on when required. He, ostensibly could control debate in the Senate, but no such problem is contemplated.

During a Senate discussion of the system in January, Sen. George Murphy (R-Calif.) pointed out that astronauts, 240,000 miles from the earth could be heard and understood by the earthpeople, but most often a Senator could not be heard by his colleagues yards away on the Senate floor:

Murphy also spoke about his throat operation which left him hoarse. The operation for a cancer near his vocal chords was a complete success, he disclosed. "I have never felt healthier, but at times I sound like a cross between Everett Dirksen and Andy Devine," he commented. Murphy pointed out that it would be difficult for him to address the Senate had not his colleagues extended him the courtesy of using a throat amplifier.

Murphy made a telling point when he assured Senators that the presence of microphones would not lead to longer speeches. He suggested that speeches would be shorter, since "we are inclined to make longer speeches. . . and we are repititious for fear that we have not been understood the first time."

Senate approval is expected any day now, assuring the Senate an equal voice with the House in the legislative branch.



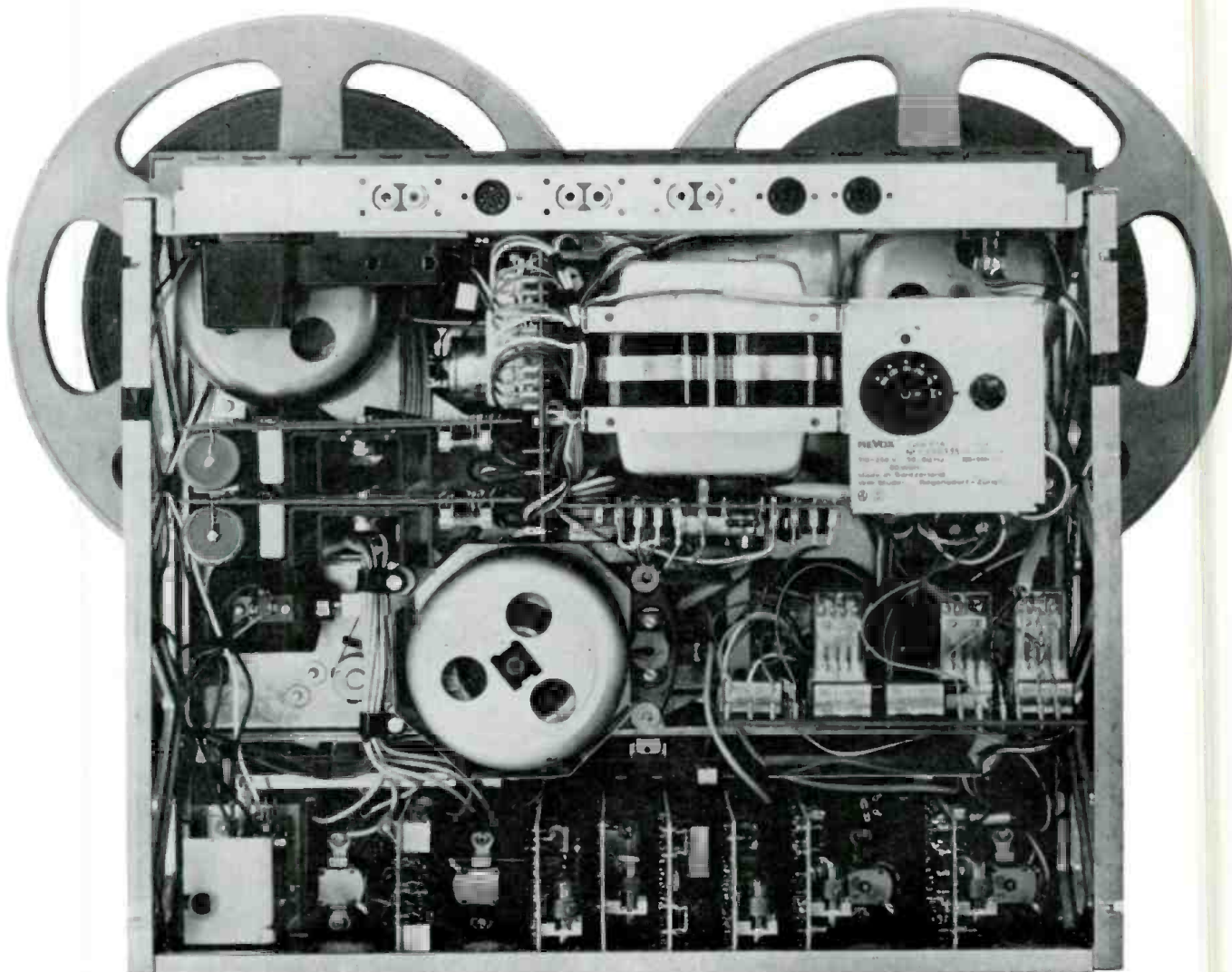

## the inside story of Willi Studer

The Revox A77 is Willi Studer's brain child... born from years of experience designing magnetic recording equipment for the broadcasting and recording industries. This is a great machine that comfortably outperforms recorders costing even three times as much.

As noted in the report by Hirsch-Houck Laboratories: "At 7-1/2 ips, the response was within +0.5, -2.0 dB from 20 to 20,000 Hz. This has never been equalled by any other recorder we have tested. It is one of the handsomest, as well as best-performing, tape recorders we have seen. We have never seen

a recorder that could match the performance of the Revox A77 in all respects, and very few that even come close. It sounds as good as it tests, which speaks for itself."

To know the detailed inside story on Willi Studer's Revox A77 read the fully descriptive story from REVOX CORPORATION 212 Mineola Avenue, Roslyn Heights, N.Y. 11577 Telephone (516) 484-4650

In Canada contact  
Tri-tel Associates Ltd Toronto Canada

# REVOX

Circle 25 on Reader Service Card

[www.americanradiohistory.com](http://www.americanradiohistory.com)

# Improved Tape Quality

MAX R. CANNON

Tape quality on high-speed professional recorders is now superb — particularly when specialized improvement techniques are utilized.

The author explains a number of substantial ways to improve the sound from home-type machines such as are often used professionally, with particular attention to signal-to-noise improvements.

**M**OST NON-STUDIO TAPE RECORDERS are capable of producing high-fidelity audio recordings. On many of these machines, however, it is difficult to achieve a true reproduction of the original sound because a poor signal-to-noise ratio limits the available dynamic range of the input signals. If the recording level is not properly adjusted, loud program segments may be distorted or quiet segments may be buried in background noise. This problem becomes emphasized when tapes are dubbed. The cumulative effect of distortion and noise can be quite objectionable on a second- or third-generation tape.

The recording process adds background noise to the input signal. Most of this unwanted signal comes from the tape,

but the equipment also contributes some noise.<sup>1</sup> Tape noise is generally in the form of a hiss or a print-through signal from an adjacent recorded tape layer. Many recorders introduce some hum in addition to a small amount of broadband noise. Stereo machines also suffer from a certain amount of crosstalk between the two channels.

A good tape recorder has low distortion at moderate signal levels. Large signal peaks, present in nearly all sounds, can cause serious distortion if they reach the *over-record* level. As these signal peaks cannot always be accurately predicted much less seen on indicating meters, the recording level is set lower than it need be to accommodate the highest input signal. Although this practice reduces distortion, it simultaneously accentuates the noise problem.

## INCREASED DYNAMICS

An ideal tape recorder would accept input signals with a wide dynamic range, record these signals without critical operator adjustments, and faithfully reproduce the original dynamic range of the input signal without added noise or distortion. There are a number of known techniques for increasing the dynamic range capability of tape recorders. Many of these

---

*Max R. Cannon is an engineer with International Business Machines Corp. in Boulder, Colorado. As a nineteen-year veteran of the company he has worked extensively in customer engineering and product development, including magnetic tape for computer systems. He is a member of the SMPTE and an affiliate of the NAB.*

techniques are used only in professional studio equipment, because of the high cost involved. A few of these systems will be described briefly.

An obvious way to improve dynamic-range capability is to increase the signal-to-noise ratio (s/n) of the tape recording system. Increasing the track width will improve the s/n somewhat. But a double-width track improves the s/n by only 3 dB. (S/n is proportional to the square root of the track width.) Higher tape speed will also improve the s/n. Although beneficial, these hardware modifications involve a high tape cost. Master duplicating machines used in the recording industry operate with wide tracks and high tape speed (15 or even 30 in./sec.). Their low-noise electronics improve s/n 6 to 10 dB over a high-quality, four-track home recorder. But even this ratio is not sufficient to produce the desired recording quality. The use of low-noise tape can improve s/n by several more dB on any type of recorder. Other techniques must be used, however, if additional noise improvements are desired.

The simplest method of keeping the input signal at an acceptable level is to continuously monitor and adjust the recording level. The signal is manually decreased during loud periods and increased during quiet periods, thus compressing the dynamic range of the recorded signal. It is impractical to manually expand the signal to its original dynamic range on playback. However, the compressed signal is satisfactory or even desirable for many applications, but it must be recognized that it is not a true reproduction of the original signal.

Signal-controlled volume expanders are available to expand large signals and compress small signals. Although they expand the dynamic range, they cannot exactly compensate for a manual compression. If a constant-amplitude, high-frequency pilot tone is added to the input signal, its amplitude during playback indicates the amount of compression. An automatic gain control circuit (a.g.c.) can then automatically increase or decrease the playback signal to maintain the pilot tone at constant amplitude.<sup>2</sup> This simultaneously restores the input signal to its original dynamic range. Noise and distortion can be minimized by a skilled recorder operator.

## AGC AMPLIFIERS

It is not necessary to manually control the recording level. Signal-controlled a.g.c. amplifiers which automatically monitor and adjust signal level are available from a number of sources. These devices are widely used in communications systems to maintain a high information signal relative to

background noise. Radio broadcasters use them to maintain a high modulation level without overmodulation. A number of technical papers describe the operating principles and unique characteristics of such devices.<sup>3-7</sup> An automatic compressor of this type eliminates the need for the operator to continuously monitor the recording level. It can be used with a pilot tone or with a complementary automatic expander to restore the original dynamic range.

An automatic expander is a signal-controlled a.g.c. amplifier similar to the compressor. The control signal which operates the expander, however, differs from the control signal which operates the compressor. The expander does not exactly compensate for the volume changes made by the compressor. This characteristic often causes a noticeable distortion when the signal amplitude changes suddenly. Overshoots, undershoots, breathing, swishing, pumping, ducking, and thumps are descriptive names frequently applied to the peculiar sounds which result from poor compression and expansion.

## NOISE REDUCTION

A noise-reduction system overcomes most of the objections to signal-controlled compression and expansion. The incoming signal is divided into four separate frequency bands for compression and expansion. This device does not alter high-level signals, but does increase the low-level signals by 10 to 15 dB.<sup>8-10</sup> This equipment has gained wide acceptance in the recording industry but is limited by cost mostly to the more sophisticated professional applications.

A completely different approach to the problem involves the use of double-channel recording.<sup>1</sup> One channel is recorded at a level 15 dB higher than the other. On playback, an electronic switch selects the best channel. A machine using this technique is available for professional use. It uses frequency-selective and amplitude-selective track switching on 70-mil-wide tracks.

Other techniques are available for achieving better s/n and dynamic range characteristics. For example, the biased, direct-recording technique normally used for audio recording can be replaced by another method, such as frequency modulation. Some improvement in s/n can be obtained at higher tape speeds by deviating from the standard NAB equalization characteristics.<sup>11</sup>

Signal compression followed by complementary expansion after transmission through all noise sources can significantly improve s/n and available dynamic range. To avoid undesirable side effects, truly complementary (or identical) de-

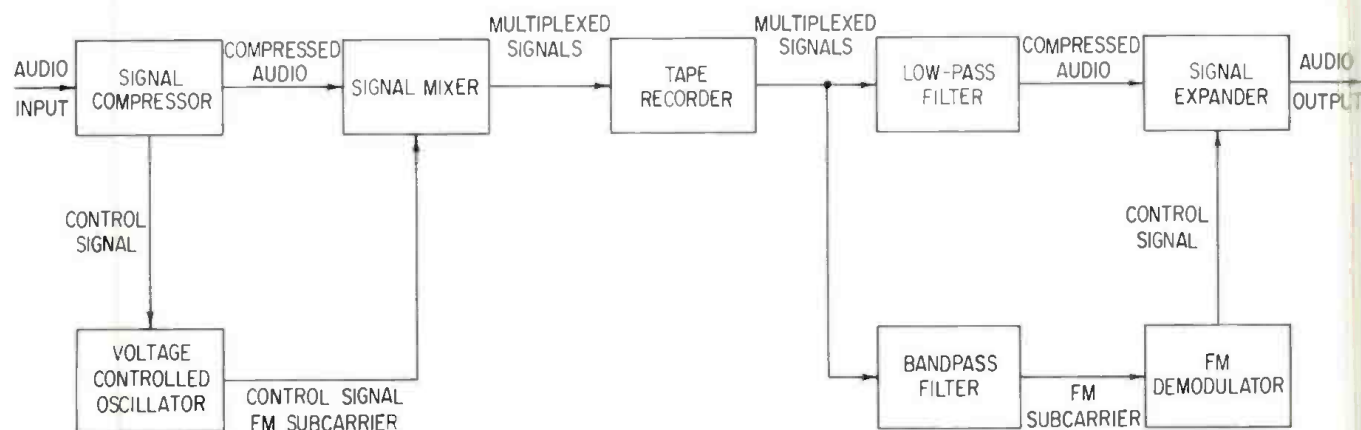

Figure 1. A block diagram of a tape-noise reduction system.

vices must be supplied with identical (or complementary) control signals. This is generally not the case with signal-controlled a.g.c. units. If the control signal is multiplexed with the compressed input signal, it is available for controlling a complementary expander at the final point of use. Bandwidth of the control signal is relatively narrow, but its frequency spectrum extends down to d.c.

A number of a.g.c. circuits have been tested in this type of system with varying degrees of success. A 15 dB improvement in tape recorder s/n has been achieved with negligible side effects. Additional apparent improvement can be obtained with a squelch circuit which operates when the input falls below a predetermined low signal threshold. This circuit overrides the normal control signal to decrease the gain of both the compressor and expander during program lulls. Thus, the compressor and expander have complementary characteristics except during squelch periods when both amplifiers have low gain.

An f.m. subcarrier for the control signal gives good results in this type of operation. The control signal can be recorded above the normal upper frequency limit of the tape recorder. For example, a 20-kHz subcarrier has been used with an 18-kHz tape recorder. The control signal carrier is of fairly low amplitude in the playback signal; it can be easily filtered out, if it is audible. FIGURE 1 is a block diagram of such a system.

Under some conditions, such as background music, the compressed signal is more desirable than the original full-range sound. The control signal gain can be easily adjusted to provide any degree of expansion from none to more than normal. The result of varying the expansion is comparable to varying the amount of compression. Because the expander

follows the compressor, no new sounds are added. Of course, if the compressor adds undesirable sounds to the input signal, the expander will not remove them. Therefore, good compressor design is of utmost importance. The design of audio signal compressors is rather complicated and will not be discussed here. Several good compressors are available now. Some of these can be modified to obtain the control signal during compression and permit insertion of an external control signal for expansion.

## OTHER APPLICATIONS

This technique is not limited to tape recorder use. One interesting possibility is its use in f.m. broadcasting. The control signals for two stereo channels can be easily accommodated by the Subsidiary Communications Authorization (s.c.a.) band which has been allocated by the FCC. Any f.m. station which is not using the s.c.a. band for other purposes could broadcast a multiplexed control signal for operation of expanders at the receiver. Most radio stations compress their signals, and this would give the listener the ability to recover the original dynamic range and improve s/n. Of course, such a step would require a set of standards and the use of an expander-adapter at the receiver. The problem is no more difficult than the switch from the old to the new f.m. band or the introduction of stereo-f.m. broadcasting. FIGURE 2 shows the essentials of an f.m. multiplex system.

A similar system could even be used with phonograph records. The control signals could be multiplexed above the audio signals at about 20 kHz on each channel.

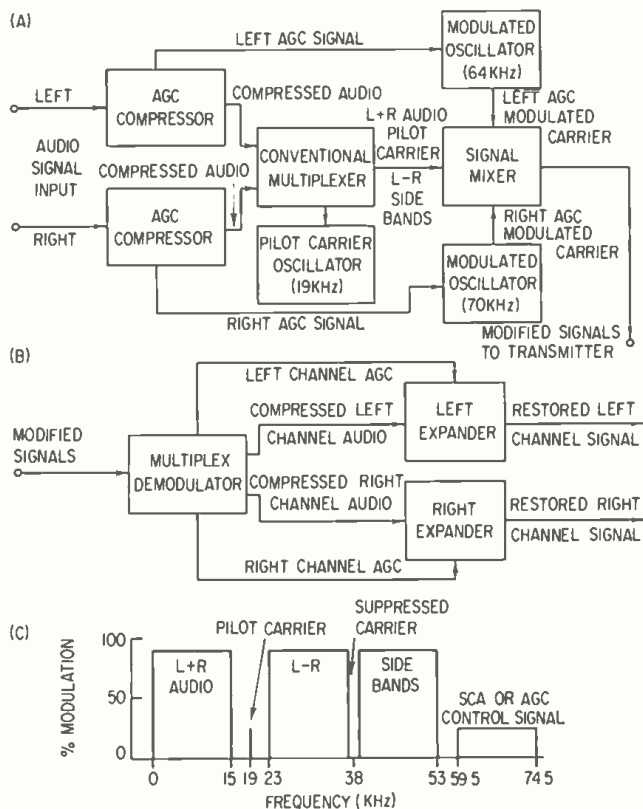

Figure 2. This block diagram indicates a possible system for noise reduction with f.m. multiplex.

## REFERENCES

- 1 John T. Mullin, *Advanced Tape Mastering System: Electronic Features*. *IEEE Transactions on Audio*, March-April 1965, pp. 31-35.
- 2 L. H. Bedford, *Improving the Dynamic Range of Tape Recording*. *Wireless World*, March 1960, pp. 104-106.
- 3 A. C. Norvide, *Devices for Controlling Amplitude Characteristics of Telephonic Signals*. *Bell System Technical Journal*, No. 4, 1938, pp. 539-554.
- 4 R. O. Carter, *Theory of Syllabic Companders*. *Proc. IEE*, Vol. III, No. 3, March 1964, pp. 503-513.
- 5 A. Kaiser and B. B. Bauer, *A New Automatic Level Control for Monophonic and Stereophonic Broadcasting*. *IRE Transactions on Audio*, No. 6, 1962, pp. 171-173.
- 6 Donald Aldous, *NoisEx Recording System*. *International Broadcast Engineer*, No. 10, 1965, pp. 510-512.
- 7 D. C. Connor and Richard S. Putnam, *Automatic Audio Level Control*. *Journal of the Audio Engineering Society*, Vol. 16, No. 3, July 1968, pp. 314-320.
- 8 Ray M. Dolby, *An Audio Noise Reduction System*. *Journal of the Audio Engineering Society*, Vol. 15, No. 4, October 1967, pp. 383-388.
- 9 Ray M. Dolby, *Audio Noise Reduction: Some Practical Aspects, Part I*. *Audio*, Vol. 52, No. 6, June 1968, pp. 19-22.
- 10 Ray M. Dolby, *Audio Noise Reduction, Part II*. *Audio*, Vol. 52, No. 7, July 1968, pp. 26-30.
- 11 J. G. McKnight, *Signal-To-Noise Problems and a New Equalization for Magnetic Recording of Music*. *Journal of the Audio Engineering Society*, Vol. 7, No. 1, January 1959, pp. 5-12.

# Up with People!



## WHEN QUALITY COMES FIRST

"Up With People" insures a dynamic musical production. The exhilarating show, comprising 150 young people on stage with orchestra, large chorus, many smaller groups and soloists, has performed around the world in a wide variety of acoustical environments.

### THE REQUIREMENT:

To accurately control the complexity and quality of sound, the audio control console was to be located at the point where the sound is heard. This necessitated placement of the complete console in the small space between two rows of typical auditorium seats in the center of the listening audience. "Up with People" Technical Director, Leif D. Larsen, placed special emphasis on obtaining the finest console performance available.



### THE SOLUTION:

Utilizing SPECTRA SONICS system designs and components, a versatile 25 input / 4 channel custom recording / sound reinforcement console, containing pre-listen/cue, echo, pan systems, graphic type equalization, filter, etc. was fabricated.

### THE PERFORMANCE:

This unique SPECTRA SONICS console not only met the stringent requirements of size (16" x 16" x 31" overall), but exhibited outstanding system performance: 80 dB console signal-to-noise ratio at +4 dBm output with -50 dBm input;  $\pm 3$  dB console frequency response, 20 Hz to 20 kHz; and unmeasurable console harmonic distortion, 30 Hz to 20 kHz. For similar results contact your distributor or: SPECTRA SONICS, 770 Wall Avenue, Ogden, Utah 84404, Telephone (801) 392-7531.

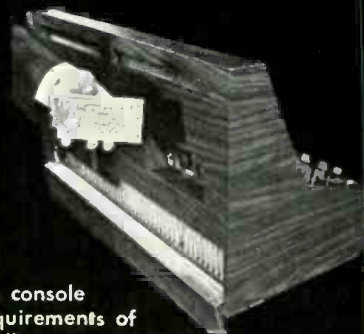

# SPECTRA SONICS

LEADER IN ADVANCED TECHNOLOGY



# Theory and Practice

NORMAN H. CROWHURST

● Just as I think I've answered all the questions in a certain subject area — in this case crossovers and matching — I get a letter from a reader asking a question I haven't answered. Back in October and November, I discussed crossovers at some length, particularly the electronic variety, and then last month I was writing about matching. What I didn't discuss was what happens to matching when you use multi-way units with a crossover.

## IMPEDANCE MATCHING THROUGH CROSSEVERS

All readers of this magazine know, I am sure, that a crossover "works" when terminated on each output with its nominal impedance. By the word in quotes, we mean it reflects the correct

constant resistance and delivers the correct frequency range to each unit. Presumably, you also know that the term *constant resistance* assumes such correct termination: it won't reflect that correct constant impedance value if the resistance is not there.

There's nothing magical about the circuit element values in a constant resistance crossover system, that makes it reflect a constant resistance, irrespective of how it is terminated. If you terminate it with a resistance on each output, of the nominal value for which the crossover is designed, the input impedance will reflect this value as constant resistance.

Actual terminations can deviate from this ideal in two ways, and the question that readers ask is what happens then? First, if the nominal value of one or other unit is not that for which the

crossover is designed; and second, any speaker has an impedance that deviates from its nominal, or rated value (that we discussed in the previous issue): what effect does that have?

A first assumption we must make, especially in the absence of better information, is that a speaker's impedance approximates its rated impedance. We know it cannot be a constant resistance at all frequencies, but this is the best information we have, very often. So under these circumstances, the best procedure is to terminate each output with a unit of correct-rated impedance.

But perhaps the units we want to use just don't happen to have the same impedance. What then? Then the best thing to do is to use a small autoformer that will make the impedance connected to the crossover output agree with the design value, and with the other unit.

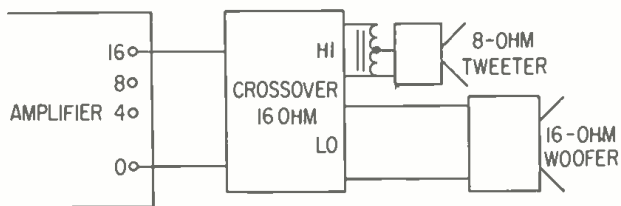

Figure 1. One way of using speakers of differing impedances with a single crossover, using an autoformer to match on the output side. The autoformer only has to handle the frequency range delivered to that speaker.

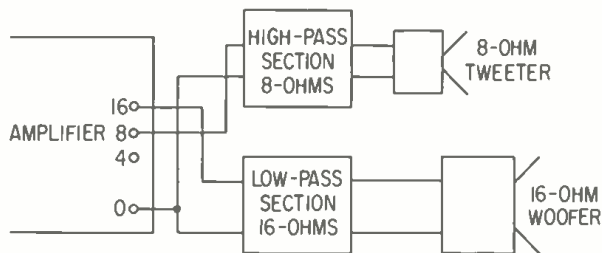

Figure 2. An alternative solution — a specially designed filter, with separate sections to suit each impedance, connected to separate amplifier taps.

# Harvey's is selling stuff you may not know exists.

There is still an information gap in the broadcast and recording fields today. Sometimes we find ourselves distributing an exciting new product that many professionals don't even know exists.

For example, did you know that there's a new slide-type studio fader that's unusually narrow, and sets new standards for smooth, quiet operation. It was developed using conductive-plastics technology, by a British aircraft firm that knew just what to do with it: they brought it to Harvey's.

Harvey's is up to its tape hubs in new equipment. Such as a superfast master and ten-slave system instantaneously compatible with either cartridges or cassettes. A whole line of table-top cassette or cartridge duplicators. Tape-winding machines that turn tape pancakes into cassettes or cartridges that'll sell like hotcakes.

In case you were wondering where to get the automatic tape degausser that accommodates everything from 150 mil tape to the new 2" tape, Harvey's has it. Along with a special production degausser for tape-duplicating plants.

Of course, if we told you about all the new, exciting products that only Harvey's has, you might not write to us, phone us, or send for our newsletter. So instead we'll just say that we have the most complete line of broadcast and tape-duplicating equipment in the U.S.

Including a lot of stuff you may not know exists.

## Harvey Radio Co., Inc.

Professional A/V Division, 2 West 45th St., New York, N.Y. 10036. (212) JU 2-1500.

Circle 27 on Reader Service Card

[www.americanradiohistory.com](http://www.americanradiohistory.com)

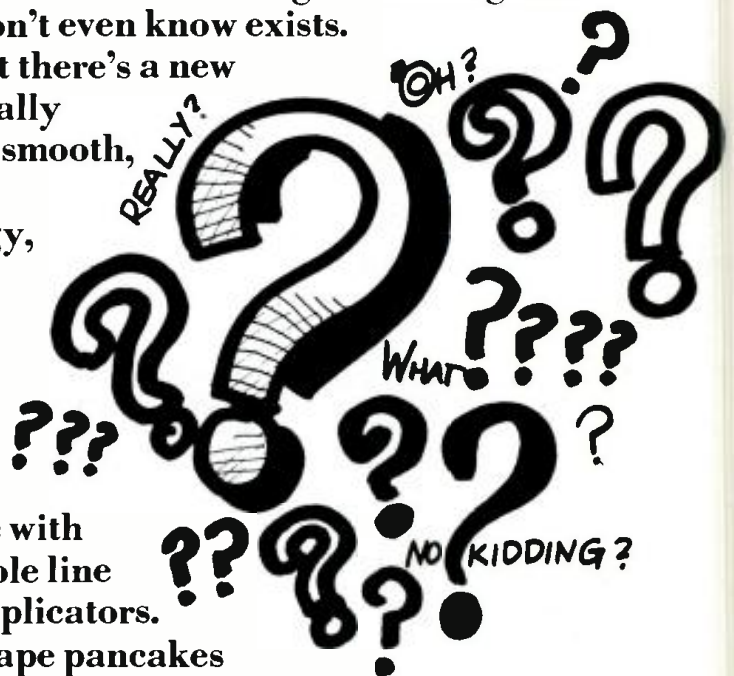

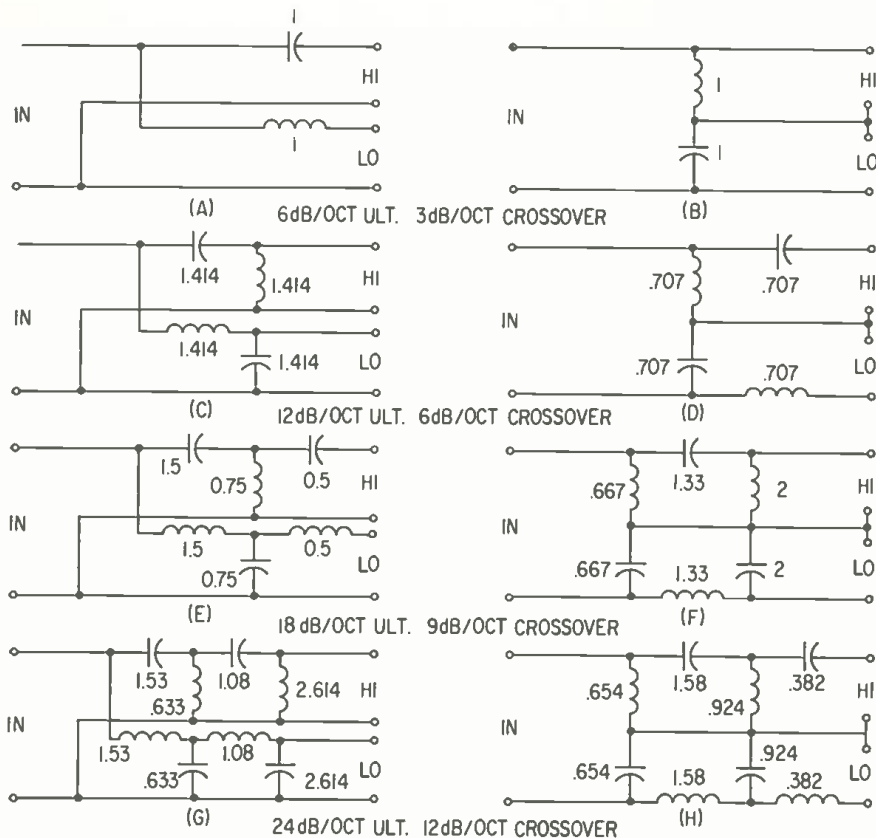

Figure 3. The variety of possible constant-resistance crossovers possible. The numbers against the elements represent the reactance at crossover, normalized to the working impedance. This means if the working impedance is 16 ohms, and the value indicated in 1.5, the reactance must be  $1.5 \times 16$  or 24 ohms at crossover frequency.

constant the impedance reflected through the filters is, due to the fact that the speaker units do not possess impedance characteristics that are of constant resistance.

The behavior of crossover filters in this regard can be divided into two parts, by frequency: the pass range, which consists of frequencies where the filter doesn't do anything but make a connection, and may be thought of as being those frequencies beyond about an octave from crossover; and the crossover range, which can be regarded as extending about an octave each side of the actual crossover frequency.

In the pass range, each filter connects the unit at its output, virtually directly to the input. So the impedance seen at the input is the same as that connected to the output. The complete impedance characteristics will be reflected through, in these ranges: the woofer impedance characteristic will be the input impedance in the woofer pass range, and the tweeter impedance characteristic will be the input impedance in tweeter pass range.

In the crossover range, the elements of both filters contribute actively to the reflected impedance. If each filter is correctly terminated, in this frequency range, the impedances reflected through each are complementary, such that combining them in parallel or series (as shown in FIGURE 3), results in a constant impedance.

But if the impedance is not a resistance of the correct value within this frequency range, the value reflected back will differ from the design value in more complicated fashion.

For example, in the networks of FIGURE 3-C, terminating the outputs with an impedance that is higher than nominal reflects an impedance that is lower than nominal. Note that the values are such that leaving the networks open-circuit at the output leaves the filters as series-resonant-tuned circuits across the input, which means the

That's usually the simplest (FIGURE 1).

There is an alternative (if you can make your crossover from components tailored to your needs) when the amplifier has more than one output tap. Each filter can be designed for the speaker impedance with which it is used, and then the inputs are connected to the appropriate amplifier taps (FIGURE 2). This limits the crossover type to those whose inputs at parallel connected.

To put this in perspective, FIGURE 3 shows crossovers for all slopes from 6 dB/octave at crossover) to 24 dB/octave ultimate (12 dB/octave at crossover), with element values given in the reactance normalized to working impedance at crossover frequency.

To apply this information to the arrangement of FIGURE 2, assume the woofer is 16-ohms and the tweeter is 8-ohms, with a crossover at 800 Hz. The woofer filter needs inductors with reactances of 24 ohms and 8 ohms at 800 Hz, and a capacitor with a reactance of 12 ohms.

A reactance chart gives the required values as 4.8 mH, 1.6 mH and 16.7 mFd.

For the 8-ohm tweeter, the filter needs capacitors with reactances of 12 ohms and 4 ohms at 800 Hz, and an inductor with a reactance of 6 ohms.

A reactance chart gives these values as 16.7 mFd, 50 mFd, and 1.2 mH. The complete circuit is shown at FIGURE 4.

So much for what to do, according to the nominal impedances of the speakers. But now comes the question of how

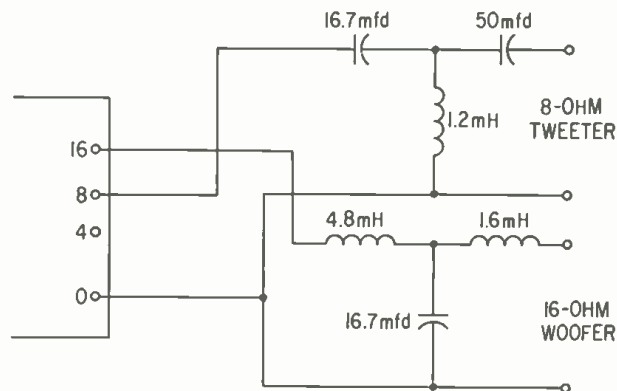

Figure 4. The completed filter of Figure 2, for a crossover frequency of 800 Hz, and the divided impedances.



# So what's new in recording?



### 250 Hz crossover dual limiter.

Solid state design uses concept of spectral separation to eliminate problems of envelope distortion and loss of program following a high energy peak. Has dual band dual release and single band dual release controls. Stereo operation is accomplished by using two limiters. Only \$510. Model 9473A.



### 100 watt amplifier, from 20 Hz to 20,000 Hz.

Less than 1/2 % distortion at 85 watts, and very low noise at 95dB below full output. Stable with any type load and operates either AC

or DC. Taking only 7" of rack space, the front is hinged for easy access. Priced at \$360. Model 9477A.



### 500 Hz crossover monitor/playback speaker.

Large enough (cubical volume) to provide the ultimate in low bass reproduction and extending through to an extremely smooth mid-range, on up to 22,000 Hz. Only \$398. Model 9845.

These advanced sound products are from Altec, suppliers to the professional broadcast, recording and motion picture industries for over thirty years.



A DIVISION OF BENTON & BOWLES ALTEC, INC.

Altec Lansing, Dept. DB-5  
1515 South Manchester Ave., Anaheim, Calif. 92803  
 Please have authorized Altec representative call with complete information.  
 Just send literature and technical data.

Name \_\_\_\_\_  
Company \_\_\_\_\_  
Street \_\_\_\_\_  
City \_\_\_\_\_  
State \_\_\_\_\_ Zip \_\_\_\_\_

Circle 26 on Reader Service Card

www.americanradiohistory.com

# TELCOMP'S NEW IC...OP AMP AUDIO D. A. BREAKS THE COST BARRIER...



Model A-100

- 6 OUTPUTS
- +20 DBM EACH
- 60 DB ISOLATION BETWEEN OUTPUTS
- 20 DB GAIN FOR UNITY ADJUSTMENT
- MEETS OR EXCEEDS EVERY PROFESSIONALLY RECOGNIZED AUDIO STANDARD
- 12 UNITS REQUIRE ONLY 5 1/4" RACK SPACE

**PRICE under \$175.00**

**RACK FRAME**  
Model CF-300  
(accepts 12 Model A-100's)

**POWER SUPPLY**  
Model PS-600

**ADA-7 PACKAGE**  
consisting of  
12 Model A-100  
1 POWER SUPPLY P-600  
1 RACK FRAME CF-300

For more details write or call:



2064 U S HIGHWAY 22, SCOTCH PLAINS, NEW JERSEY 07076 • (201) 233-8200

Circle 29 on Reader Service Card

Figure 5. Using reactive elements of the speaker units as elements in the constant resistance result. Here the 16.5 mFd and 1.05 mH indicated as part of the 16-ohm speaker impedances are due to motional or voice-coil impedance, and are not separate elements.

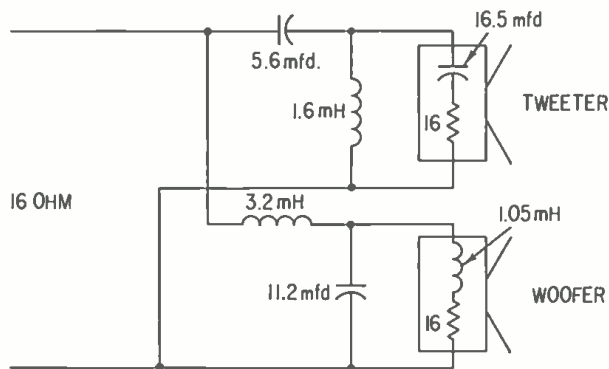

reflected impedance will be close to zero at crossover.

If the unit's impedance is higher than nominal, the reflected impedance will not be zero, but it will be lower than nominal, in the region of crossover. So connecting a 16-ohm unit to the output of an 8-ohm crossover will result in the 16 ohms being transferred directly to the input through the pass range. But as crossover is approached, the reflected impedance dips to lower than 8 ohms.

But speaker impedances don't just deviate from nominal value, still being resistances of these different values. The deviation occurs with reactive elements. At the upper end of a units range, usually the voice coil inductance becomes an appreciable portion of the impedance, to which may be added some inductive motional impedance.

At the lower end, if the unit is used only above its fundamental resonance, the motional impedance may be capacitive. It may also be inductive. In neither case is the reactive effect equivalent to a constant value inductor or capacitor. But it is possible, with a little extra care, to offset the reactive effect in the over-all design, so that matching is more nearly maintained in its correct relationship.

For example, by using the network of FIGURE 3-E, the voice-coil inductance of the woofer can be regarded as part of the output inductor. Often the voice-coil inductance may usefully be the output inductor, so that no separate component is needed in that position. At the same time, by choosing the crossover, so the tweeter resonance is below it, the motional impedance will be capacitive in the region of crossover, so the output capacitor isn't needed.

FIGURE 5 shows such an arrangement, using a 1,200 Hz crossover. Although the configuration looks like FIGURE 3-C, the circuit works like the arrangement of FIGURE 3-E, giving a sharper crossover.

All the foregoing has related to the electrical type crossover. In the October and November issues, we discussed

electronic crossovers. The problems just discussed will be largely avoided if the frequency separation is performed before the power amplifiers, so that each power amplifier has to feed only one speaker system, and no crossover interaction occurs.

But there are other factors, which we will take up in the following issue. The practical one, mentioned in October — that you can't buy a correctly-designed, sharp cut-off electronic crossover — is about the only one in favor of electrical crossovers. Everything else favors the electronic variety. But we'll go into that next time.

Many readers do not realize that they can also be writers for db. We are always seeking good, meaningful articles of any length. The subject matter can cover almost anything of interest and value to audio professionals.

Are you doing something original or unusual in your work? Your fellow audio pros might want to know about it. (It's easy to tell your story in db.)

You don't have to be an experienced writer to be published. But you do need the ability to express your idea fully, with adequate detail and information. Our editors will polish the story for you. We suggest you first submit an outline so that we can work with you in the development of the article.

You also don't have to be an artist, we'll re-do all drawings. This means we do need sufficient detail in your rough drawing or schematic so that our artists will understand what you want.

It can be prestigious to be published and it can be profitable too. All articles accepted for publication are purchased. You won't retire on our scale, but it can make a nice extra sum for that special occasion.

# Sound with Images

MARTIN DICKSTEIN

## OPTICS

● The field of image projection, whether it be by a device that throws a picture on a screen (front or rear) or by a unit which has a scanning beam hitting a retentive layer on the face of a tube, can be classified broadly as belonging to the much larger category of optic and its applications.

The definition of the extent of the term *optics* is not easy to explain if the over-all range of the electromagnetic spectrum is considered. The Greeks had a word for sight and it is from this word that the term optics is taken. Thus, we usually consider the field of optics as being limited to the range of frequencies which can be detected by the optic nerves of the eyes. . . visible light. Within the past 100 years or so, this definition has been changed radically. It is even being further broadened today. The limits presently being used are those frequencies which can be controlled by man-made devices through reflection, refraction and diffraction, by using mirrors, lenses, and gratings. This means that the previous limits were in a very small range of wavelengths between  $10^{-2}$  and  $10^{-5}$  centimeters (visible light). Now, the much broader limits are from approximately  $10^{-7}$  all the way to about  $10^{-1}$  centimeters. This is still a very small part of the electromagnetic spectrum which actually covers the range from the lower limits of X-rays  $10^{-13}$  to about the upper the limits of radio waves  $10^6$ . One of the earliest experiments with light was performed about 1800 by placing a source behind a thin surface with a pinhole in it. This in turn was placed behind another thin surface with two slots in it arranged to be on either side of the pinhole. The resulting light interference pattern of alternate light and dark bands led to the much more accurate interferometer.

One of the most widely used applica-

tions of this principle is in the coating of glass or other material with as many as 40 layers for the purpose of controlling reflection or transmission (or both) as desired for the particular application. Even though the coatings are of wavelength thick, extremely sensitive filters and reflectors can be made to operate within a very narrow band of frequencies. Since a certain amount of incident light is reflected at the surface between the layer coating and air, and a different amount of light passes through the layer to be reflected from the interface between the layer and the glass or other material, the final total of the reflections can be

made to cancel completely or to operate within tight limits. Such fine layers are found on the better lenses and filters used in spectroscopy, high-speed and microphotography, high-precision measurements, and in automatic-control devices applicable to space travel.

An interesting device which makes use of the principal of reinforcement of cancellation of two light beams (or other radiation such as infrared rays) is the automatic interferometric spectrometer. The beam of light enters the device through a large opening. It is then passed through a beam-splitter and hits an oscillating mirror controlled

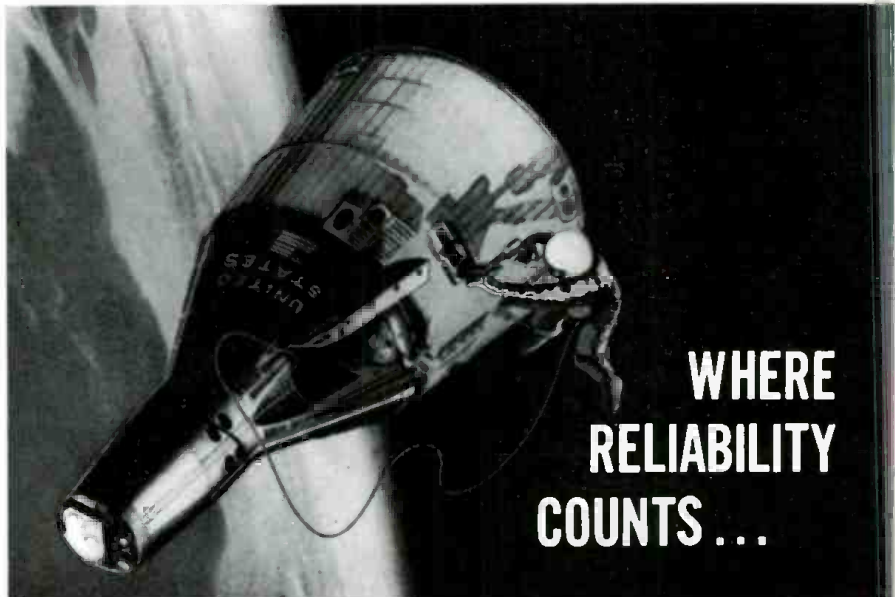

**WHERE  
RELIABILITY  
COUNTS ...**

**YOU CAN COUNT ON**

**Tandberg®  
SERIES 11**

**PORTABLE/SOLID STATE  
BATTERY OPERATED/TAPE RECORDER**

**3 Speeds — Full and ½ Track Models**



Wherever and whenever there is a critical, on-the-spot tape recording to deliver, Tandberg quality and reliability make it the professionals first choice. For many reasons. The name Tandberg and all it implies — plus "better, clearer, more natural sound" with these features: 3 separate heads; 7" reel capacity (cover off); mixing facilities with separate level controls;  $\pm 0.5\%$  absolute speed tolerance; automatic limiting control; 200 ohm monitor headphone socket; built-in speaker; accepts ten 1.5 D cell batteries; weighs 10 lbs.

### SPECIFICATIONS

Frequency Response:  $7\frac{1}{2}$  ips — 30-20,000Hz ( $\pm 2$ db 40-16,000Hz);  $3\frac{3}{4}$  ips — 30-13,000Hz ( $\pm 2$ db 50-9,000Hz);  $1\frac{1}{2}$  ips — 30-7,000Hz ( $\pm 2$ db 60-4,500Hz). Signal-to-noise Ratio: @  $7\frac{1}{2}$  ips 61 db. Wow:  $7\frac{1}{2}$  ips better than .1%;  $3\frac{3}{4}$  ips better than .15%;  $1\frac{1}{2}$  ips better than .35%. Erase & Bias Frequency: 85.5KHz  $\pm 2$ KHz; below 5% distortion. Transistor Complement: 41 transistors, 8 diodes, 2 zener diodes. \$449.50

for better, clearer, more natural sound

Also Available "PILOTONE" Model 11-1P



For Professional Sound Film Synchronization and Audio Engineering. Rugged, Cilmatized construction. Synchronizer and power supply optional.

\$699.00

**Tandberg** of America, Inc. P.O. Box 171, 8 Third Avenue, Pelham, N. Y. 10803  
914 PE 8-0772

Circle 34 on Reader Service Card

by an oscillator with a definite output wave such as a sawtooth. The beam is reflected from the mirror back toward the beam splitter where two separate beams are made. One is that portion of the beam which is reflected by the beamsplitter toward a detector. The other part of the beam is bent by the splitter toward a stationary mirror where it is again reflected through the splitter toward the same detector. By adjustment of the distances between the various reflective surfaces and the speed of oscillation of the mirror, the detector will receive a signal which will fall within the audio range. If this signal is now amplified and recorded on tape or displayed on a scope, the result can be analyzed and information gained on the spectrum of the incoming signals.

The beamsplitter used in the spectrometer is very similar to the partially silvered reflectors used in visual multiplexers, another application of the layer coating on a reflective surface. The function of the multiplexer is to permit several sources of images to be directed toward the vidicon of a closed-circuit camera. For example, it might be required to transmit a 16mm movie and two 35mm slide presentations in succession to a closed-circuit network.

It is entirely possible to project all images on a front or rear projection screen and then pick up the picture on a camera for transmission to the network. If the screen projection is necessary for an audience, then this is the method to use. However, a great deal of space is saved if the screen projection is not required by using a multiplexer. The 16mm image is directed toward the camera by reflection from two partially silvered mirrors or by projecting directly into the camera through the partial reflectors. The slides are shown by reflection from one surface and through the other partial mirror, or by reflection from one surface without going through the other partial mirror. All surfaces, being partially mirrored, transmit and reflect only a portion of the incident light. Thus, different reflection-to-transmission ratios are available for particular applications. The entire device can now be built on a single table and mounted in one section of the control room where the projectors and camera can be remotely controlled from the operating console, and the images mixed with live camera pickups if desired.

Another interesting application of the principles of light transmission and reflection is in the field of fiber optics.

Here, the entire secret is the production of a small diameter fiber or pipe with total internal reflection, the same phenomenon that allows a prism to act as a mirror. A light pipe traps incoming light (entering within a definite critical angle depending on the construction of the fiber) and by total reflection transmits the light the entire length of the fiber and emits it from the other end. The fiber is made with an inside glass core surrounded by another glass which has a lower index of refraction. The light within the core is not transmitted through the outside layer (called *cladding*) because the angle of incidence on the walls is greater than the critical angle necessary for total reflections. This process of internal reflection is so efficient that only about one quarter of one percent of the energy is lost per inch of travel. (Interestingly, as the diameter of the fiber approaches one wavelength, most of the energy is transmitted along the outside of the fiber as in the "skin effect" of electrical energy in transmission wires.) For transmission of information by use of fibers, bunches of these fine glass strands are run from the source to the viewing surface in almost any path desired. Thus, light information can be directed around otherwise impenetrable obstructions. Fiber optics are applied to the field of illumination and viewing of interiors of equipment which otherwise would be too small to get into, for flaw detection or operation checking. Medicine has made use of fiber optics by transmitting light to and viewing such organs as the heart and stomach, although small enough fibers are now made to view skin tissue, or blood cells. Fiber optics are also used in computers for information transmission from one surface to another and for very tiny indicators on panels and control boards. Of course, fiber optics are used in displays to show the tiny flashing lights of a city as seen from a high-flying plane or to pinpoint spots on a map.

Now, of course, the field of optics has taken a giant step with the development of the laser and the maser. Here, for the first time, is the possibility of using intense light for industry to cut and weld, for astronomers to attempt to communicate over tremendously long distance with other intelligent beings and for the application of radar-tracking to space travel, and as the propelling force for interplanetary travel.

As further developments take place in the fields of electro-optical devices and systems and the limits of the optic range expand through the discovery of controlling materials, the segment of the total spectrum named after the human eye will also progress and make its own contributions.

# STEP UP

... to the finest record-care accessories in the world!

# CECILE E. WATTS Ltd.

If you're setting for less than Cecil E. Watts Ltd. record-care products, you're making do with less than the best! from \$4.00 to \$15.00



Endorsed by Elpa because it successfully meets the stringent standards for performance Elpa demands. Write for invaluable volumes on record protection and care. Enclose 75¢ for postage and handling. Elpa Marketing Industries, Inc., New Hyde Park, N. Y. 11040

Circle 30 on Reader Service Card

## the growing line of Melcor Equalizers



Melcor Electronics manufactures an extensive line of Audio Products for the Professional user. Standard Active Lossless Audio Equalizers currently available feature continuous equalization control; stepped equalization; shelf or gaussian frequency response; independent multiple frequency ranges; balanced and or unbalanced input and output connections; high and low level input and output signal capability; bridging or terminated inputs. All units have ultra low noise and negligible distortion. New units featuring sharp bandpass filtering are in development.

### AVAILABLE FROM STOCK

AE-20 Amplifier Equalizer      GME-20 Graphic type Module Equalizer  
 SME-20 Shelf type Module Equalizer      EQ-20 Active Program Equalizer  
 GE-20 Graphic Equalizer—Rack Mount (not shown)

Write for descriptive literature on our lossless Equalizers

### MELCOR ELECTRONICS CORPORATION

AMPLIFIERS FOR INDUSTRY

1750 NEW HIGHWAY, FARMINGDALE, LONG ISLAND, NEW YORK 516 MYrtle 4-5570



Circle 33 on Reader Service Card

# NOW THERE'S A CASSETTE TAPE WITH MUSCLES.

New Maxell F-20 Magnetic Tape helps you make better cassette recordings—with fewer problems. Reason? Real muscle. Maxell F-20 has 10% greater tensile strength than conventional recording tape. Prevents tape breaks, headaches, lost studio time. Lower print-through level, too. And our secret Hush-Hush Tape Formula virtually wipes out hiss, delivers pure fidelity in mono or stereo. It's specially developed to give you an ultra-precise recording of fine music. Your ears will prove it—and your budget will like it. Write us today for more facts.

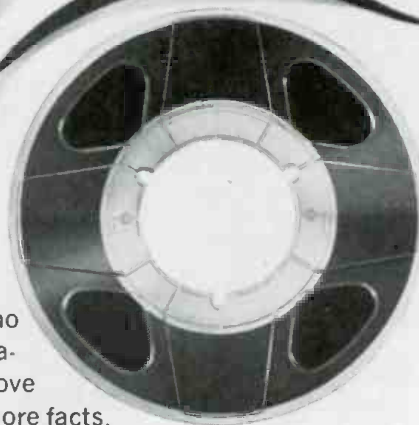

## HITACHI MAXELL, LTD.

501 Fifth Avenue, New York, N.Y. 10017

Circle 32 on Reader Service Card

www.americanradiohistory.com

# New Products and Services

## TRANSCRIPTION TURNTABLE



● The Thorens TD-125 uses an electronic transistorized drive system with a slow-speed drive motor. Speed selection is electronic at 16, 33-1/3, and 45 r.p.m. Motor control is synchronous with the drive electronics allowing a vernier speed adjustment around each of the selected speeds. The dynamically balanced turntable platter has a 12-inch diameter, the arm board is separate and replaceable.

*Mfr.: Thorens (Elpa Marketing)*

*Price: \$185 less base*

*Circle 76 on Reader Service Card*

## MONITOR SPEAKER



● A superior monitor system just announced contains two integral 30-watt solid-state amplifiers driving through an electronic crossover to a three-way system. Designated the model OY, the system is manufactured by Klein & Hummel in West Germany. Wide, smooth frequency response, superb transient response, and low distortion at high s.p.l.'s are claimed. A six-page brochure with full specifications is available.

*Mfr.: Gotham Audio Corp.*

*Circle 80 on Reader Service Card*

## AUDIO LEVEL CONTROLLER



● The Model M62 Level-Loc does not increase the strength of an audio input signal but it can reduce an overly strong signal as much as 100 times to eliminate blasting, excessive feedback, buildup, and irregular voice output; all without added distortion. Any of three hemispherical sound-control zones can be selected, depending on the application. They may be six-, twelve-, or eighteen-inches from the microphone. Sounds originating in these zones are automatically modulated. The transistorized unit may be used with a single mic, with several mics and a mixer, or with a tape recorder. It is battery powered. A separate switch allows the system to be bypassed when desired.

*Mfr.: Shure Brothers, Inc.*

*Price: \$90.00*

*Circle 81 on Reader Service Card*

## COMPACT OSCILLATOR

● 80 dB of attenuation is featured in this new precision oscillator. Amplitudes from 2.5 V r.m.s. into 600- down to less than 250  $\mu$ V r.m.s. are available. The frequency range is 5 Hz to 1.2 MHz. The model 240D offers its attenuation in 10 dB steps with an accuracy of +3%. This is +10 dB to  $\pm$ 60 dB with the additional  $\pm$ 70 dB range specified at -5%. A greater than 10 dB separate vernier provides a comfortable overlap on any range. Distortion is less than 0.1% between 30 and 100,000 Hz, hum and noise is less than 0.01% of output, and output amplitude is stable and flat: within -0.05 dB between 100 Hz and 300 kHz and within -1 dB over the rest of the range.

*Mfr.: Hewlett-Packard*

*Price: \$325 a.c. (mercury battery operation)-\$340, rechargeable batteries-\$360*

*Circle 77 on Reader Service Card*



● Model 180 series audio line amplifiers are available in 115 V a.c. and 12 V d.c. versions. All silicon semiconductor circuitry is used to provide audio power into speaker loads. Different models provide 2 to 8 watt outputs into 8 $\Omega$  loads, at full power distortions of 3.5% or less. A.c. models include an on/off switch and a built-in power supply. Input sensitivity on all models is 100 mV with the a.c. models equipped with built-in 500-k gain controls. All units are completely enclosed, ready for mounting to any flat surface.

*Mfr.: Pulse Dynamics Corp.*

*Circle 79 on Reader Service Card*

## NEW ATTENUATOR LINE

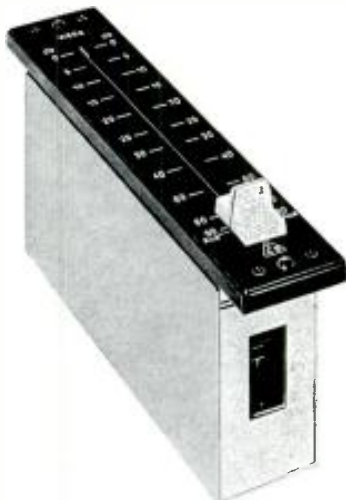

●The German-made EAB fader products have been well-known in Europe for some time. Sennheiser Electronic Corp. is now distributing the line in this country through their regular channels. Carbon-track resistance plates are used as the resistive element to achieve continuously variable control with a maximum resolution against minimum crackle pickup. A moving carbon pin is the pickup point from the track. Careful design ensures minimum wear while maintaining a constant contact pressure. Two longitudinal ball bearings provide smooth, even movements; changeover contacts at minimum position may be used for switching operations; and external contacts are by knife contacts. A number of ladder and potentiometer sliders in mono or stereo configurations are available. As potentiometers, the units may be had in log or linear characteristic. A detailed brochure may be had for the asking.  
*Mfr.: Sennheiser Electronic Corp.*  
*Circle 75 on Reader Service Card*

## PHONO AMP CARD

●Disc playback applications are the design goal for this plug-in model 104 card. It provides pre-preamplification for Ortofon cartridges without the need for their transformers and also includes precise RIAA equalization. The output of the card then goes to a standard console microphone input position or a linear amplifier. The substitution of the card for the standard stepup transformer not only provides the needed

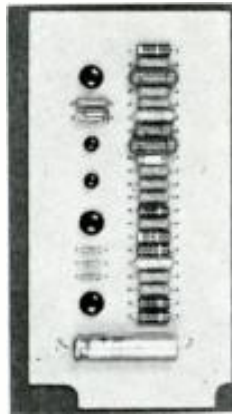

RIAA equalization but reduces the frequency discrimination, phase shift, ambient pickup, and impedance limitations of the transformers. In addition, the 3Ω output of the card and the 2Ω output of the cartridge combine to reduce by more than two orders of magnitude, the ambient hum pickup and capacitive high-frequency attenuation of long cable runs. Distortion is less than 0.01% (test residual) and noise is significantly below the record surface noise of the finest quality disc recordings. Power requirements are 24 V d.c. at 20 mA.

*Mfr.: Spectra Sonics*  
*Circle 78 on Reader Service Card*

## ORGAN KIT

●A new organ kit, low in price has been released specifically for the light music field. It has the usual two keyboards, and like more expensive instruments, the pitches available from the two are different, to take care of accompaniment and melody. There are 14 organ voices, all different and distinctive. The 29 key accompaniment keyboard goes down to the C below middle C; the 36-note solo keyboard goes up to the third E above middle C. The lowest of the 13 pedals produces the same 32.7 Hz bass pitch found on larger organs. The console is walnut veneer and solids. The kit is available directly from the manufacturer. A special seven-inch 33 $\frac{1}{3}$  r.p.m. demonstration disc is also available.

*Mfr.: Schober Organ Corp.*  
*Price: \$599.50*  
*Circle 82 on Reader Service Card*



## MANUFACTURERS SURPLUS COMPONENTS

Large quantity of level controls, single and dual potentiometers, various fixed resistors, high-wattage power transformers. Also several models of discontinued Acoustech amplifiers (various wattages), f.m. tuner and amplifier kits. Write for complete listing of quantities and prices. **Koss Electronics, 2227 North 31 Street, Milwaukee, Wisconsin. Telephone: 414-444-9442. Attn: Bob Bruecker.**

BLOW UP YOUR BUSINESS to poster size. Send any black & white or color photo, drawing, print, or promotional material from 2- to 8 x 10 inches. We will send you a 2 foot x 3 foot poster and return your original undamaged.

2 x 3 feet \$ 5.00

3 x 4 feet \$10.00

plus 50c each for postage and handling.  
**Joni Company, P.O. Box 49, Cooper Station, New York, N.Y. 10003**

## RECORDING STUDIO WANTED

Successful New York record company wishes to purchase existing VIII-track recording studio. Location midtown Manhattan. All replies confidential. Please contact giving details of equipment to **Mr. I. Schlüssel, 545 Madison Avenue, New York, N.Y. 10022**

# The db Bookcase

As a service to our readers we are pleased to offer these books from prominent technical publishers. All prices listed are the publishers' net. Shipping charges are included.

Use the coupon at the bottom of the page or give the complete title, author and coupon number. Be sure to indicate quantity on the special instructions line if more than one copy of a title is wanted. Full payment must accompany your order. We cannot ship c.o.d. Checks or money orders should be made payable to Sagamore Publishing Company, Inc. Because of the time required to process orders, allow several weeks for the receipt of books.

## Broadcasting

### RADIO BROADCASTING

edited by Robert L. Hilliard. Each of the five chapters has been written by a prominent educator with an extensive background of practical experience in commercial and educational broadcasting. The areas covered include: management and programming, operating and studio facilities, producing and directing, writing, performing. For those of you who want to, or must, operate on both sides of the control room, this is virtually required reading. 190 pages; 6 1/4 x 9 1/2; indexed, clothbound.

**\$6.95 (\$8.35 in Canada)**  
Circle 2 on Coupon Below

## Reference

### New 17th Edition of the famous RADIO HANDBOOK

Tells how to design, build and operate the latest types of amateur transmitters, receivers, transceivers, amplifiers and test equipment. Provides extensive, simplified theory on practically every phase of radio. Broad coverage; all original data, up to date, complete. 847 pages.

**\$12.95 (\$15.50 in Canada)**  
Circle 10 on Coupon Below

## How To

### PRACTICAL PA GUIDEBOOK: HOW TO INSTALL, OPERATE AND SERVICE PUBLIC ADDRESS SYSTEMS

by Norman H. Crowhurst. 1967. This book gives all the basics needed to become a successful PA operator, in any situation where the reinforcement, relay, or distribution of sound can provide a service. It shows how to properly install, operate and service public address systems. All aspects of the subject, from survey to the selection of appropriate equipment, to installation, to routine operation and the maintenance of a finished system, are covered. Attention is given to solving problems encountered in providing successful service. The book's systematic and practical approach makes it highly useful to radio-TV servicemen, hobbyists, and PA equipment manufacturers. 136 pages; 6 x 9; illus.; softbound.

**\$3.95 (\$4.60 in Canada)**  
Circle 15 on Coupon Below

### CLOSED-CIRCUIT TELEVISION HANDBOOK

by Leon Wortman. Gives comprehensive detailed information about the field in an easy-to-understand presentation. It's particularly suited to those who plan to use, install, and service cctv. Covers the subject from the simple single-camera system to the most exotic systems. 288 pages; 5 1/2 x 8 1/2; clothbound.

**\$7.95 (\$9.50 in Canada)**  
Circle 18 on Coupon Below

## Electronic Music

### ELECTRONIC MUSICAL INSTRUMENTS

by Richard H. Dorf. Now in its third edition and sixth printing since its first appearance in 1954, this is considered the authority on electronic organs. This edition is completely rewritten to explain everything technical about today's organs. The book is of special value to organ designers and service technicians as well as electronics-minded hobbyists and prospective organ purchasers. Of special value are the author's many practical comments and expressions of opinion based on his years of musical, engineering, and management experience with electronic musical instruments. 393 pages; 239 diagrams and photographs.

**\$10.00 (\$11.95 in Canada)**  
Circle 19 on Coupon Below

## General Audio

### THE TECHNIQUE OF THE SOUND STUDIO

by Alec Nisbett. This is a handbook on radio and recording techniques, but the principles described are equally applicable to film and television sound. It describes how the highest standards may be achieved not only in the elaborately equipped studio but also with simple equipment out on location. 264 pages; 60 diagrams; glossary; indexed; 5 1/2 x 8 1/2; clothbound.

**\$10.50 (\$11.95 in Canada)**  
Circle 1 on Coupon Below

### DESIGN OF LOW-NOISE TRANSISTOR INPUT CIRCUITS

by William A. Rheinfelder. 1964. Written for students as well as circuit design engineers interested in low-noise circuit design. Throughout, the book gives a multitude of time-saving graphs and design curves for the practical circuit designer. Simple derivations of all important formulas are also presented to help the reader obtain a deeper insight into the fundamentals of practical low-noise design. 128 pages; 6 x 9; illus.; clothbound.

**\$5.50 (\$6.50 in Canada)**  
Circle 14 on Coupon Below

## Electronics and Mathematics

### ELECTRONICS MATH SIMPLIFIED

by Alan Andrews. For the engineer, student, or technician who requires a knowledge of mathematics as it pertains to electronics. Covers the subject in a logical, clear, and concise manner, using dozens of examples related specifically to electronics. Particularly suited for use as a textbook in any school or other training program involving the study of electronics, the book has been especially prepared to coincide with studies leading to 2nd- and 1st-class FCC Radiotelephone licenses. (2 vols. in slipcase)

**\$7.95 (\$9.95 in Canada)**  
Circle 11 on Coupon Below

### MATHEMATICS FOR ELECTRONICS ENGINEERS & TECHNICIANS

by Norman H. Crowhurst. This book is written to help the advanced technician and the engineer bridge the gap between "book learning" and practical experience. It is not about mathematics but about how to use mathematics in electronics. A unique programmed method shows not only how to apply textbook math towards the solution of any electronics problem but also teaches how to think in the best way for solving them. Much emphasis is placed on correcting misconceptions commonly held by technicians. The book begins with Ohm's and Kirchhoff's laws and goes on to selective networks, properties of coils and transformers, feedback circuits, etc. 256 pages; 5 1/2 x 8 1/2 (hardbound).

**\$6.95 (\$8.35 in Canada)**  
Circle 4 on Coupon Below

Sagamore Publishing Company, Inc.  
980 Old Country Road, Plainview, N.Y. 11803

Please send me the books I have circled below. My full remittance in the amount of \$..... is enclosed. N.Y. State residents add 5% sales tax.

1 2 3 4 5 6 7 8 9 10 11 12 13 14 15 16 17 18 19 20 21 22  
23 24 25 26 27 28 29 30 31 32 33 34 35 36 37 38 39 40

Name.....

Street Address.....

City.....State.....Zip.....

Special Instructions.....



## HANDBOOK OF ELECTRONIC TABLES & FORMULAS, (3rd Edition)

A one-stop source for all charts, tables, formulas, laws, symbols, and standards used in electronics. Devotes complete sections to items of interest to service technicians and to circuit design data. Includes a 8-page, full-color fold-out chart showing latest FCC allocations for the entire frequency spectrum. 232 pages, 5½ x 8½, hardbound.

\$5.50 (\$6.60 in Canada)  
Circle 8 on Coupon Below

## Test and Maintenance

### INTERMODULATION AND HARMONIC DISTORTION HANDBOOK

by Howard M. Tremaine. A complete reference guidebook on audio signal intermodulation and harmonic distortion. 172 pages, 5½ x 8½, softbound.

\$4.25 (\$5.25 in Canada)  
Circle 9 on Coupon Below

## Circuitry and Components

### PASSIVE AUDIO NETWORK DESIGN

by Howard M. Tremaine. A complete and comprehensive guide to the design, construction, and testing of all types of attenuators, equalizers, and wave filters for the practicing audio technician or engineer. This authoritative text is one of the few written on the subject, and requires only nominal mathematical background. Written in easy-to-understand language, the content presents the basic design, construction, and testing considerations without the confusion often associated with passive networks. 288 pages, 5½ x 8½, softbound.

\$5.50 (\$6.45 in Canada)  
Circle 5 on Coupon Below

### TRANSISTORS FOR AUDIO FREQUENCY (AUDIO-FREQUENCY AMPLIFICATION)

by Guy Fontaine. 1967. This systematic and detailed treatment of the application of transistors in audio-frequency amplifiers shows how the published transistor characteristics are related to the principles of design. To assure clarity, the figures are rendered in several colors and placed opposite the related text. Simple equations reinforce the lucid approach. An ideal textbook or reference on the subject for engineers and advanced technicians. 384 pages, 5½ x 8, illus., clothbound.

\$7.95 (\$9.55 in Canada)  
Circle 12 on Coupon Below

### ACOUSTICAL TESTS AND MEASUREMENTS

by Don Davis. Provides a solid understanding of the entire subject of acoustical measurements; based on actual field test work, using commercial equipment. Contains practical, time-saving solutions to actual problems encountered in the field; minimum math is required for understanding. The author is an expert in this field, and an authority on auditorium acoustics. An invaluable book for phone company special service engineers, plant maintenance engineers, communications engineers, noise control specialists, architectural engineers, broadcast engineers and technicians, hi-fi fans and students. 192 pages, 5½ x 8½, hardbound.

\$6.95 (\$8.35 in Canada)  
Circle 7 on Coupon Below

# Classified

Closing date is the fifteenth of the second month preceding the date of issue. Send copy to:

Classified Ad Dept.

db

THE SOUND ENGINEERING MAGAZINE  
980 Old Country Road  
Plainview, New York 11803

Rates are 50c a word for commercial advertisements. Non-commercial and employment offered or wanted placements are accepted at 25c per word.

## EMPLOYMENT

PROFESSIONAL RECORDING PERSONNEL SPECIALISTS. A selective service for employers and job seekers: engineers, tape editors, production and studio mgrs, traffic assts, etc. Call us today! Smith's Personnel Service, 1457 Broadway, N.Y.C. 10036. Alayne Spertell 212 WI 7-3806.

SOUND SYSTEM ENGINEERS and sound system servicemen with experience in audio-visual and c.c.t.v. preferred. East Side — Midtown Manhattan. Immediate openings. All information kept confidential. Send resume and salary requirements to Box F1, db Magazine, 980 Old Country Road, Plainview, N.Y. 11803

SALES ENGINEER. Prominent audio equipment manufacturer seeks top notch man with experience in recording equipment. Should have degree in electronic engineering or equivalent experience in recording studio operation. Involves relocation and travel. Send resume, in confidence to Box 5, db Magazine, 980 Old Country Road, Plainview, N.Y. 11803

## FOR SALE

SOLID-STATE 50 WATT RMS plug-in d.c. thru 25 kc operational power amplifier kit, model 440K. Price \$30.00. Send for free catalog and 50 operational amplifier applications to: Opamp Labs. 172 So. Alta Vista Blvd., Los Angeles, California 90036.

AUDIO AND VIDEO JACK PANELS and patch cords. 500-500 ohm repeat coils. New and used. Send for list. Gulf Electro Sales, 6325 Beverly Hill, Houston, Texas 77027

NOW AVAILABLE at outstanding savings, brand-name pro-audio studio equipment. Equalizers, preamps, faders, mixers, etc. Write Box F3, db Magazine, 980 Old Country Road, Plainview, N.Y. 11803 for a comprehensive listing.

SCULLY TAPE RECORDERS — one to twenty-four track and model 270 auto players, many models in stock for immediate delivery. SCULLY LATHES — Previously owned and rebuilt. Variable or automatic pitch. Complete cutting systems with Westrex heads. MIXING CONSOLES — Custom designed using Wiegand Audio Lab modules. From \$7,000.00. Wiegand Audio Laboratories, 3402 Windsor Road, Wall, New Jersey 07719. Phone: 201 681-6443.

## EDUCATION

EARN YOUR ELECTRONICS ENGINEERING degree, mostly by correspondence. G.I. Bill approved. Credit allowed for previous training and experience. Free Catalog. Write: Dept. E-3, Grantham School of Electronics, 1505 N. Western, Hollywood, California 90027.

## SERVICES

WHATEVER YOUR EQUIPMENT NEEDS — new or used — check us first. Trade your used equipment for new. Write for our complete listings. Broadcast Equipment & Supply Co., Box 3141, Bristol, Tenn. 37620.

CUSTOM STYLUS — cartridge re-tipping, re-building, replacements. International Audio Stylus Corp., 111-D Lake Ave., Tuckahoe, New York, 10707 (Telephone: (914) SP9-1297.

SMALL VOLUME CASSETTE OR OPEN REEL tape duplication done. Also limited producing. BDC Recording, Box 2062 West Lafayette, Indiana 47906

# People, Places, Happenings



**Berliner**

● Los Angeles' Watts Training Center has engaged audio-video consultant **Oliver Berliner** for a series of lectures on studio practices to be given to Negroes and Mexican-Americans who have shown aptitude and interest. Mr. Berliner, who is the grandson of inventor Emile Berliner, has already begun the indefinite number of free lectures and practice sessions that are given once weekly at **Telaudio Centre Studios** (located near Disneyland). The series, currently conducted for twenty students covers the field from microphone selection and placement through disc cutting and pressing.

"Two things continue to amaze me", said Berliner, "the students' ability to grasp the information and techniques quickly although they have no background in it, and the fact that the so-called underprivileged are getting instruction in an area where heretofore nobody from any of life's strata was able to get this attention."

**Frank Baird-Smith, Jr.**, of NBC is chief inspector for the series which covers, radio, t.v. film, recording, and general.

● The **Telex Communications Division**, based in Minneapolis, has announced the combining of all its offices into a single facility at 9699 Aldrich Avenue South. The Telex offices at 3054 Excelsior Boulevard have been closed. The new divisional headquarters, which has 33,000 square feet, is the former Viking tape recorder assembly plant (acquired by Telex in 1966. Division management, marketing, accounting, and engineering and technical services will be in the remodeled building.

● **Superscope Incorporated** has recently begun a unique program of producing braille instruction manuals for three tape recorders, according to **Nate Tushinsky**, vice-president production. The manuals will be free on request. "With the increasing use of tape recorders by the blind as one of their primary sources of education, relaxation, and entertainment, we believe that these people should have the dignity of self-sufficiency in being able to operate and care for their recorders without help," Tushinsky said. The manuals will be for the Sony models 100, 104, and 105. They will be produced by the Boston-based **National Braille Press Inc.**, a non-profit organization serving the blind and handicapped.



**Goldman**

**Gerald Goldman** has been appointed director, v.t.r. and t.v. systems department of **Sonocraft Corporation**. The announcement by chairman of the board **Mr. Borhardt** goes on to say that Mr. Goldman was previously manager, product development and applications, educational and commercial systems department, **General Telephone & Electronics International**. He was also manager applications engineering in the commercial electronics division of **Sylvania Electric Products Inc.** In his new association, he will provide customers with guidance, installation, and servicing of all v.t.r. and t.v. systems sold through Sonocraft.



**Haverty**

● A number of changes have taken place at **McMartin Industries** according to an announcement by **Ray B. McMartin**, company president.

**C. Duane Haverty** has been named as one of three new vice presidents. He becomes v.-p. marketing and engineering. Mr. Haverty joined the company in 1965 as a broadcast product manager. Prior to this he had been a manufacturers' representative in the electronics industry.

Other vice presidencies went to **James A. Taphorn** who becomes v.p. and treasurer, and **Ken L. Kohler**, v.-p. manufacturing. Mr. Taphorn joined the firm as its controller in 1965 while Mr. Kohler, who has been with the firm since 1964, has held the posts of production manager and director of manufacturing.

● **Metrotech Incorporated** of Mountain View, California has been acquired by **Dictaphone Corporation of Rye, New York** according to a joint announcement by both firms. The company will operate as a Dictaphone Division under the management of **E. A. Feichtmeir**. He is the former president of Metrotech and now becomes president of the division. Dictaphone Corporation is an international company that manufactures dictating machines, recording systems for professional and aerospace uses (Scully), office furniture, and business forms and supplies. It also supplies temporary office services.

**this is  
the world's  
most popular  
headphone  
koss pro-4A  
stereophones**



**this is the world's  
finest headphone  
koss esp-6  
electrostatic  
stereophones\***

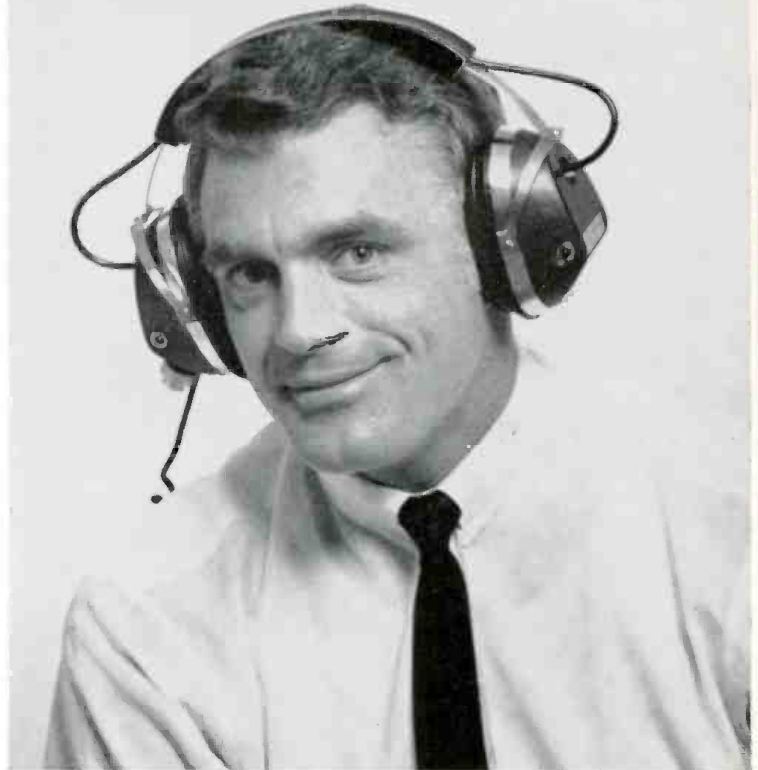

Since 1962, the famous Koss PRO-4A has been the most popular stereo headphone in the world. It still is! It has also been the finest. The PRO-4A became the most popular because it was the finest. But excellent though the PRO-4A is, Koss engineers have gone it one better. Now it must bow to the superb . . . a professional headphone employing electrostatic reproduction elements previously useable only in very large, high-priced speaker systems like the Koss-Acoustech X system. Because of this technological breakthrough, the ESP-6 reproduces 9 of a possible 10 octaves the human ear can hear.

What about the PRO-4A? Well, it's almost humorous to think of it as "second best". It's still the same precise, exciting sound. Still the same durable quality. Were it not for such a dramatic development as Electrostatic Stereophones, it would still be well ahead of the pack!



**model esp-6  
electrostatic  
stereophones  
\$95.00**

complete with fitted,  
portable carrying case  
and individually  
measured response curve.

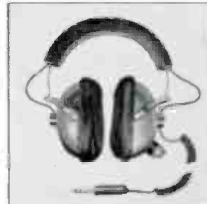

**model pro-4A  
stereophones  
\$50.00**

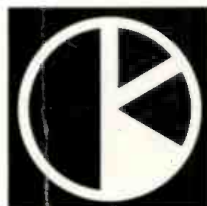

**KOSS**

KOSS ELECTRONICS INC.  
2227 N. 31st Street • Milwaukee, Wis. 53208

Export: Koss Electronics S.r.l.  
Via Bellini 7, 20054/Nova Milanese, Italia

Export Cable: Stercolone



\*Patents applied for

*Circle 6 on Reader Service Card*

The industry needs one more module..... **ours!**

**If you want total control  
and the ability to give your clients  
the really wild sounds they want—  
the choice of Components is obvious.**

Datamix Systems and Components are  
in the studios that make money!!

Expensive?  
You better believe it.



**Datamix Systems and Components, 884 10th Avenue  
New York, N. Y. 10019, Telephone 212-765-4230**

Circle 7 on Reader Service Card

[www.americanradiohistory.com](http://www.americanradiohistory.com)